

GRAD-EXPORT[®]
since 1992.
PROIZVODNJA DEKORATIVNIH PANELA



PVC & HPL
2020./2021.



Jedan od najvažnijih osjećaja u ljudskom životu je osjećaj sigurnosti.

GRAD-EXPORT d.o.o taj osjećaj nikad ne stavlja na drugo mjesto i to potvrđuje dugogodišnjom tradicijom.

Naši dekorativni paneli sadrže sve važne komponente dekorativnih panela - kvalitetu, mogućnost odabira brojnih modela, elegantan i decentan dizajn, kao i dugotrajnost panela.

Jamčimo našim proizvodom...



PROGRAM CLASSIC - str. 6-37

ANTIN str. 26
 BERAK str. 30
 BOSUT str. 15
 CERIĆ str. 6
 CERNA str. 20
 DARDA str. 35
 DUKAT str. 23
 GUNDINCI str. 32
 ILOK str. 13
 IVANKOVO str. 25
 JANKOVCI str. 22
 KANOVCI str. 11
 KOMLETINCI str. 14
 LIPOVAC str. 16
 LOVAS str. 33
 LUG str. 31

MARINCI str. 24
 MECE str. 29
 MIKANOVCICI str. 27
 NIJEMCI str. 36
 NUŠTAR str. 17
 OROLIK str. 34
 OTOK str. 18
 PRIVLAKA str. 28
 SIKIREVCI str. 37
 SLAVONIJA str. 9
 SOPOT str. 7
 TOVARNIK str. 21
 VINKOVCI str. 10
 VUKOVAR str. 19
 ZALUŽJE str. 8
 ŽUPANJA str. 12

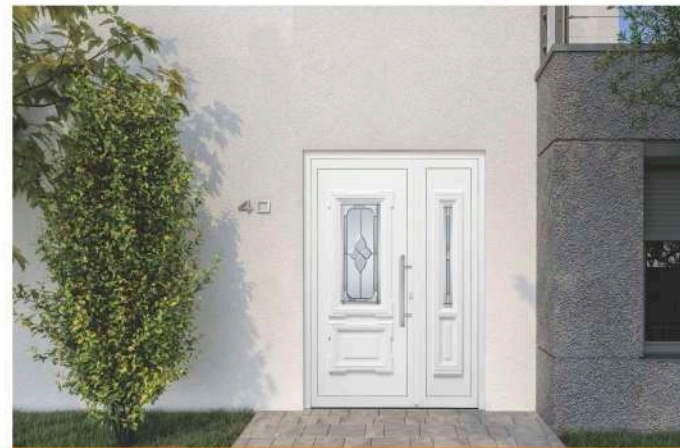

PROGRAM EXCLUSIV - str. 50-51

BARANJA str. 51
 PANONIA str. 50

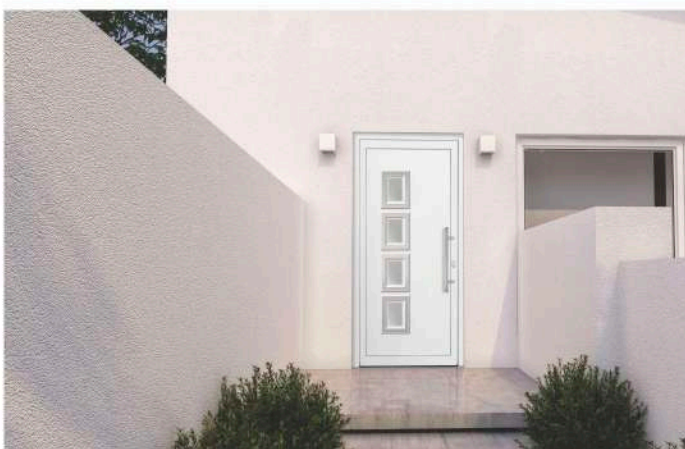

PROGRAM MODERNA - str. 38-49

BOL str. 46
 HUM str. 43
 IST str. 49
 KRK str. 41
 NIN str. 42
 PAG str. 47
 RAB str. 39
 VIR str. 45
 VIS str. 40
 VRH str. 48
 ŽUT str. 44



PROGRAM ELEGANT - str. 52-59

CETINA str. 53
 DOBRA str. 55
 DRAVA str. 54
 FLO str. 59
 KUPA str. 52
 LEA str. 57
 REA str. 56
 SAVA str. 58



PROGRAM PREMIUM - str. 60-65

ANA str. 63
DEA str. 62
ELA str. 60
EVA str. 65
IVA str. 61
TEA str. 64



PROGRAM VIZUAL - str. 74-79

CH str. 75
DK str. 77
FR str. 79
HU str. 76
IT str. 74
NL str. 78



PROGRAM ARTÉ - str. 66-73

BOTTICELLI str. 67
DALI str. 72
DEGAS str. 73
GOYA str. 69
KLIMT str. 70
MONET str. 66
RENOIR str. 68
VERMEER str. 71



PROGRAM FUTURE - str. 80-111

BIOKOVO str. 82
BRIJUNI str. 92
DILJ str. 84
DVOR str. 100
ERDUT str. 87
GALOVAC str. 103
HVAR str. 85
JANKOVAC str. 107
JEZERCE str. 105
KALI str. 86
KLEK str. 101
KOPAČKI RIT str. 102
KORNATI str. 81
KOZJAK str. 96
LASTOVO str. 109
LONJA str. 110

MEDVEDNICA str. 93
MLJET str. 90
MURTER str. 89
OLIB str. 88
PAKLENICA str. 94
PLITVICE str. 80
PAPUK str. 91
PSUNJ str. 97
RASTOKE str. 111
RISNJAK str. 95
SKRADIN str. 104
STON str. 98
TELAŠČICA str. 108
VRANA str. 99
VRSAR str. 83
ŽUMBERAK str. 106

TEHNIČKI PODATCI - str. 112
OPIS KATALOŠKIH OZNAKA - str. 113
STAKLA - str. 114
HPL BOJE I DRVNI DEKORI - str. 118
PVC-ABS I BOJE ALUMINIJA - str. 120
DODATCI - str. 121
PARAPETI I RAVNE SENDVIČ PLOČE - str. 122

CERIC

Dimenzija panela 900x1920mm; min. dim. 560x1600mm; Dimenzija polupanela 450x1920mm; min. dim. 260x1600mm



CR-FB-F0-3



CR-PJ-5



CR-MADRAS UADI-1



CR-DM-BL-3+P-CR-DM-BL-2

Dimenzija panela 900x2100mm; min. dim. 560x1600mm; Dimenzija polupanela 450x2100mm; min. dim. 260x1600mm



SO-FAB-3 + P-SO-FAB-2



SO-VC-1



SO-AB-SL-3



SO-FB-FK-3 + P-SO-FB-FK-2

ZALUŽJE

Dimenzija panela 900x1920mm; min. dim. 600x1560mm

IZ TEHNIČKIH RAZLOGA U MODELU ZALUŽJE NISU VIŠE DOSTUPNA ORNAMENT STAKLA S LAJSNAMA



ZA-DM-M3



ZA-DPB-V3



ZA-DK-4



ZA-FAB-V3

Dimenzija panela 900x1920mm; min. dim. 600x1610mm; Dimenzija polupanela 450x1920mm; min. dim. 240x1610mm

IZ TEHNIČKIH RAZLOGA U MODELU SLAVONIJA NISU VIŠE DOSTUPNA ORNAMENT STAKLA S LAJSNAMA



SL-V0-8+P-SL-V0-4



SL-MADRAS PAVÉ-6

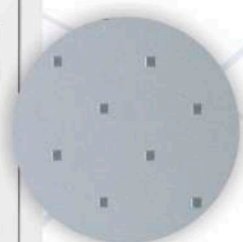

MADRAS PAVÉ



SL-DPH-8+P-SL-DPH-4



SL-VFB-8

VINKOVCI

Dimenzija panela 900x2100mm; min. dim. 560x1600mm; Dimenzija polupanela 450x1920mm; min. dim. 260x1600mm

IZ TEHNIČKIH RAZLOGA U MODELU VINKOVCI NISU VIŠE DOSTUPNA FAB, VFB I ORNAMENT STAKLA S LAJSNAMA



VK-DPB-V



VK-FPK-V



VK-FB-FO-V



VK-SPS-V+P-VU-SPS-1

Dimenzija panela 900x1920mm; min. dim. 600x1600mm; Dimenzija polupanela 450x1920mm; min. dim. 260x1600mm

IZ TEHNIČKIH RAZLOGA U MODELU KANOVCI NISU VIŠE DOSTUPNA ORNAMENT STAKLA S LAJSNAMA



KA-FAB-6 + P-KA-FAB-3



KA-VO-6



KA-DPJ-6



KA-DPH-6 + P-KA-DPH-3

ŽUPANJA

Dimenzija panela 900x2100mm; min. dim. 560x1600mm; Dimenzija polupanela 450x2100mm; min. dim. 260x1600mm

IZ TEHNIČKIH RAZLOGA U MODELU ŽUPANJA NISU VIŠE DOSTUPNA FAB, VFB I ORNAMENT STAKLA S LAJSNAMA



ŽU-DPJ-V



ŽU-DPR-V



ŽU-DPB-V



ŽU-POL-V+P-IL-POL-1

Dimenzija panela 900x2100mm; min. dim. 500x1600mm; Dimenzija polupanela 450x2100mm; min. dim. 260x1600mm



IL-AB-GL-1+P-IL-AB-GL-1



IL-FB-FP-1+P-IL-FB-FP-1



IL-DPJ-1



IL-PJ-1

KOMLETINCI

Dimenzija panela 900x2100mm; min. dim. 600x1590mm

IZ TEHNIČKIH RAZLOGA U MODELU KOMLETINCI NISU VIŠE DOSTUPNA FAB, VFB I ORNAMENT STAKLA S LAJSNAMA



KO-POL-V



KO-PJ-M



KO-PZM-V



KO-DPH-V



BO-ČB-SL-3



BO-FB-F0-3



BO-MADRAS PAVE-3



BO-VFB-1

LIPOVAC

Dimenzija panela 900x1920mm; min. dim. 560x1600mm



LI-FB-FK-V3



LI-AB-V3



LI-DK-GL-V3



LI-VFB-V3

IZ TEHNIČKIH RAZLOGA U MODELU NUŠTAR NISU VIŠE DOSTUPNA ORNAMENT STAKLA S LAJSNAMA



NU-DPH-6



NU-FAB-6



NU-MK-6



NU-DPR-6

OTOK

Dimenzija panela 900x2100mm; min. dim. 600x1600mm

IZ TEHNIČKIH RAZLOGA U MODELU OTOK NISU VIŠE DOSTUPNA FAB, VFB I ORNAMENT STAKLA S LAJSNAMA



OT-PZM



OT-DPL



OT-PTF



OT-DPF

Dimenzija panela 900x1920mm; min. dim. 560x1600mm; Dimenzija polupanela 450x1920mm; min. dim. 260x1600mm



VU-ČB-BL-2+P-VU-ČB-BL-1



VU-V0-2



VU-ML-2



VU-FB-FK-2+P-VU-FB-FK-1

CERNA

Dimenzija panela 900x1920mm; min. dim. 600x1600mm

IZ TEHNIČKIH RAZLOGA U MODELU CERNA NISU VIŠE DOSTUPNA STAKLA FAB, VFB I ORNAMENT STAKLA S LAJSNAMA



CN-DPJ-V



CN-FPK-V



CN-PJ-V



CN-DPT-V

Dimenzija panela 900x1920mm; min. dim. 560x1600mm; Dimenzija polupanela 450x2100mm; min. dim. 260x1600mm

IZ TEHNIČKIH RAZLOGA U MODELU TOVARNIK NISU VIŠE DOSTUPNA STAKLA FAB, VFB I ORNAMENT STAKLA S LAJSNAMA



TO-DPJ-V



TO-FPK-V + P-IL-FPK-1



TO-DPL-V

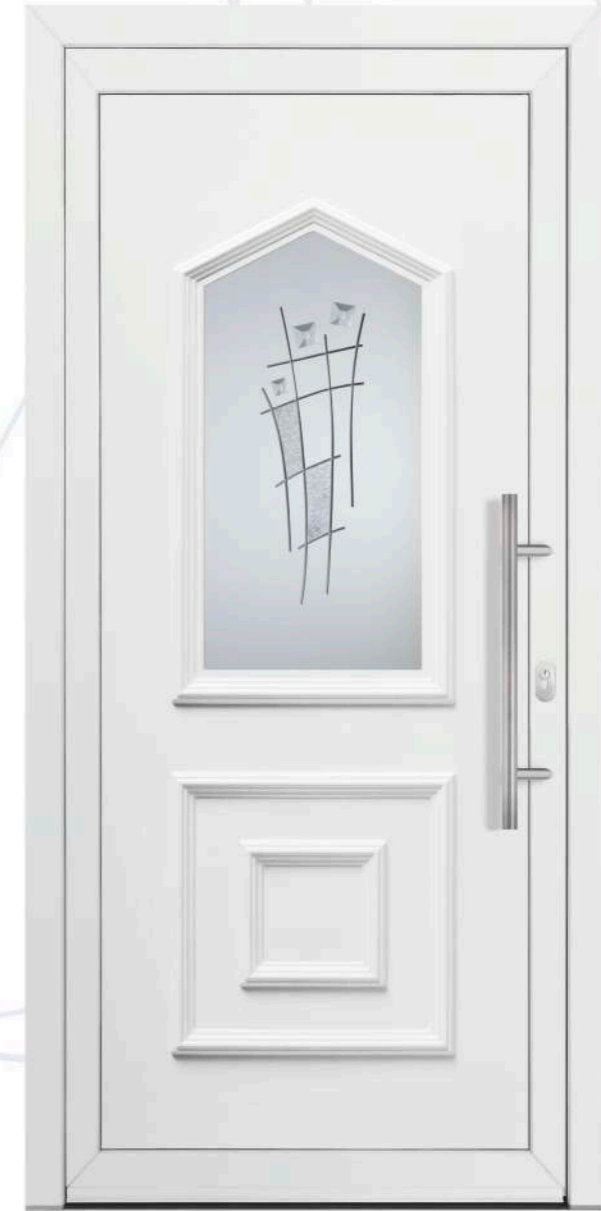

TO-PMB*-V

**Staklo PMB nije dostupno u panelima debljine 24mm.*

JANKOVCI

Dimenzija panela 900x2100mm; min. dim. 580x1660mm

IZ TEHNIČKIH RAZLOGA U MODELU JANKOVCI NISU VIŠE DOSTUPNA ORNAMENT STAKLA S LAJSNAMA



JA-FB-FP-3



JA-DPJ-3



JA-FAB-3



JA-MADRAS UADI-3

IZ TEHNIČKIH RAZLOGA U MODELU DUKAT NISU VIŠE DOSTUPNA STAKLA DUV, FAB, VFB I ORNAMENT STAKLA S LAJSNAMA



DU-MADRAS PAVÉ-M

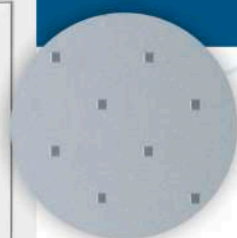

MADRAS PAVÉ



DU-DPB-V



DU-DPH-V



DU-PTB-V

MARINCI

Dimenzija panela 900x2100mm; min. dim. 620x1660mm

IZ TEHNIČKIH RAZLOGA U MODELU MARINCI NISU VIŠE DOSTUPNA ORNAMENT STAKLA S LAJSNAMA



MA-DPB-3



MA-PLS-3



MA-FB-FK-3



MA-DPS-2

IZ TEHNIČKIH RAZLOGA U MODELU IVANKOVO NISU VIŠE DOSTUPNA ORNAMENT STAKLA S LAJSNAMA



IV-PFB



IV-DPM



IV-SPM



IV-PFL

ANTIN

Dimenzija panela 900x2100mm; min. dim. 600x1660mm; Dimenzija polupanela 450x2100mm; min. dim. 290x1660mm

IZ TEHNIČKIH RAZLOGA U MODELU ANTIN NISU VIŠE DOSTUPNA ORNAMENT STAKLA S LAJSNAMA



AN-DPJ-2



AN-FPK-2+P-AN-FPK-2



AN-FAB-2



AN-FB-FC-2

Dimenzija panela 900x2100mm; min. dim. 620x1560mm; Dimenzija polupanela 450x2100mm; min. dim. 310x1560mm



MI-TOP-2



MI-DPH-2



MI-DPL-2+P-MI-DPL-1



MI-AB-SL-2+P-MI-AB-SL-1

PRIVLAKA

Dimenzija panela 900x2100mm; min. dim. 600x1660mm; Dimenzija polupanela 450x2100mm; min. dim. 290x1660mm

IZ TEHNIČKIH RAZLOGA U MODELU PRIVLAKA NISU VIŠE DOSTUPNA ORNAMENT STAKLA S LAJSNAMA



PR-FPK-7



PR-PJ-7+P-PR-PJ-4



PR-V0-7



PR-FAB-7+P-PR-FAB-4

Dimenzija panela 900x2100mm; min. dim. 550x1600mm; Dimenzija polupanela 450x2100mm; min. dim. 400x1600mm



ME-DPJ-4



ME-SPM-4



ME-DPR-4+P-ME-DPR-4



ME-PLS-4

BERAK

Dimenzija panela 900x2100mm; min. dim. 700x1700mm



BE-PTB



BE-DPB



BE-DPH



BE-FPK

Dimenzija panela 900x2100mm; min. dim. 550x1600mm; Dimenzija polupanela 450x2100mm; min. dim. 350x1600mm



LU-DPK



LU-DPH



LU-PLM



LU-ML+P-LU-ML

GUNDINCI

Dimenzija panela 900x2100mm; min. dim. 700x1600mm



GU-PTB



GU-FPK



GU-DPL



GU-PZM



LO-FAB



LO-PGF



LO-WO



LO-DPJ

OROLIK

Dimenzija panela 900x2100mm; min. dim. 500x1600mm

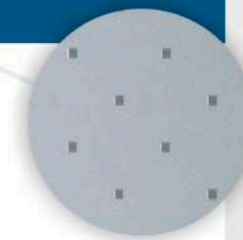

MADRAS PAVÉ



OR-DPL-2



OR-PFL-2



OR-MADRAS PAVÉ-2



OR-SPM-2

Dimenzija panela 900x2100mm; min. dim. 550x1600mm; Dimenzija polupanela 450x2100mm; min. dim. 350x1600mm



DA-PFL



DA-MK



DA-DPH + P-DA-DPH



DA-SPF

NIJEMCI

Dimenzija panela 900x2100mm; min. dim. 500x1600mm



NI-DPL-2



NI-PTK-2



NI-PFM-2



NI-DPJ-2



SI-DPS-3



SI-PLM-3



SI-DPJ-3



SI-DPH-3



Dimenzija panela 900x1920mm; min. dim. 500x1560mm; Dimenzija polupanela 450x1920mm; min. dim. 280x1560mm



SV-RAB-VK-4



INXV-RAB-FAB-4



SV-RAB-DPJ-4+P-SV-JAZ-DPJ-2



INXV-RAB-FPK-4

VIS

Dimenzija panela 900x1920mm; min. dim. 500x1560mm; Dimenzija polupanela 450x1920mm; min. dim. 280x1560mm



SV-VIS-DPH-2



SV-VIS-VO-2 + P-SV-JAZ-VO-2



SV-VIS-DPJ-2



INXV-VIS-WK-2

Dimenzija panela 900x1920mm; min. dim. 570x1560mm; Dimenzija polupanela 450x1920mm; min. dim. 280x1560mm



INXV-KRK-DPJ-3



INXV-KRK-FAB-3



SV-KRK-MK-3



SV-KRK-FPK-3+P-SV-JAZ-FPK-2



SV-NIN-DPB-3



INXV-NIN-DPJ-3



SV-NIN-FPK-3



SV-NIN-FAB-3

Dimenzija panela 900x1920mm; min. dim. 500x1560mm; Dimenzija polupanela 450x1920mm; min. dim. 280x1560mm



SV-HUM-DPJ-4



SV-HUM-DPH-4



INXV-HUM-DPR-4



INXV-HUM-ML-4 + P-INXV-JAZ-ML-2

ŽUT

Dimenzija panela 900x1920mm; min. dim. 500x1560mm



INXV-ŽUT-VFB-1



SV-ŽUT-MADRAS PAVE-1



SV-ŽUT-WP-1



SV-ŽUT-FPK-1

Dimenzija panela 900x2100mm; min. dim. 500x1560mm; Dimenzija polupanela 450x2100mm; min. dim. 280x1560mm



INXV-VIR-KT-4



SV-VIR-DPJ-4



INXV-VIR-PFL-4 + P-INXV-IŽ-PFL



SV-VIR-PFM-4

BOL

Dimenzija panela 900x2100mm; min. dim. 610x1560mm; Dimenzija polupanela 450x2100mm; min. dim. 280x1560mm



SV-BOL-FPK-2



INXV-BOL-PTB*-2 + P-INXV-IŽ-PTB*

*Staklo PTB nije dostupno u panelima debljine 24mm.



SV-BOL-VFB-2



SV-BOL-PZK-2

Dimenzija panela 900x2100mm; min. dim. 590x1560mm; Dimenzija polupanela 450x2100mm; min. dim. 280x1560mm



SV-PAG-VK



SV-PAG-DPJ



SV-PAG-WP+P-SV-IŽ-WP



INXV-PAG-FPK+P-INXV-IŽ-FPK

VRH

Dimenzija panela 900x2100mm; min. dim. 600x1500mm



SV-VRH-PFL-3



INXV-VRH-DPT-3



SV-VRH-VFB-3



SV-VRH-DPJ-3

Dimenzija panela 900x2100mm; min. dim. 500x1560mm; Dimenzija polupanela 450x2100mm; min. dim. 280x1560mm



SV-IST-DPL-3



INXV-IST-FPK-3 + P-INXV-IŽ-FPK



INXV-IST-DPH-3



SV-IST-DPR-3

PANONIA

Dimenzija panela 900x1920mm; min. dim. 600x1610mm; Dimenzija polupanela 450x2100mm; min. dim. 310x1610mm



PAN-FM-S



PAN-FM-F9-S+P-SRI-PA-F9-S



PAN-FPK

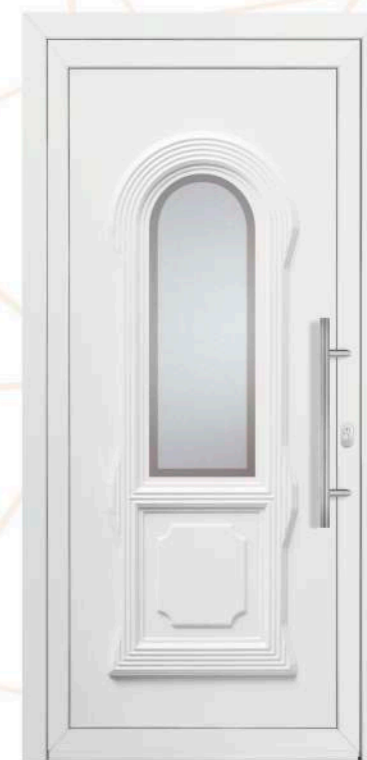

PAN-DPJ

Dimenzija panela 900x2100mm; min. dim. 600x1600mm; Dimenzija polupanela 450x2100mm; min. dim. 310x1610mm



BAR-DPB



BAR-DPH



BAR-FM-F8-Z



BAR-FM-F4-S+P-SRI-BA-4-S

KUPA

Dimenzija panela 900x1920mm; min. dim. 560x1500mm; Dimenzija polupanela 450x2100mm; min. dim. 270x1560mm



INXV-KUP-PTB*-2

**Staklo PTB nije dostupno u panelima debljine 24mm.*



SV-KUP-XLP-2



INXV-KUP-FAB-2



SV-KUP-SPS-2+P-SV-MIR-SPS

Dimenzija panela 900x1920mm; min. dim. 500x1560mm; Dimenzija polupanela 450x1920mm; min. dim. 270x1560mm



SV-CET-TOK-2



SV-CET-PKB-2



INXV-CET-FAB-2



INXV-CET-FPK-2 + P-INXV-ODR-FPK-2

DRAVA

Dimenzija panela 900x1920mm; min. dim. 540x1560mm; Dimenzija polupanela 450x2100mm; min. dim. 270x1560mm



SV-DRA-DPJ-1



SV-DRA-SPS-1



SV-DRA-DPR-1



SV-DRA-ML-2+P-SV-MIR-ML

Dimenzija panela 900x2100mm; min. dim. 580x1560mm; Dimenzija polupanela 450x2100mm; min. dim. 270x1560mm



SV-DOB-FAB-2



SV-DOB-DPJ-2



INXV-DOB-DPH-2



INXV-DOB-WK-2 + P-INXV-MIR-WK

REA

Dimenzija panela 900x2100mm; min. dim. 550x1600mm; Dimenzija polupanela 450x2100mm; min. dim. 290x1590mm



SV-REA-MADRAS PAVÉ-2

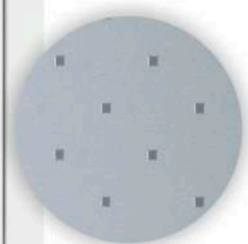

MADRAS PAVÉ



INXV-REA-TOP-2+P-INXV-KIA-TOP



INXV-REA-FPK-2



SV-REA-DPL-2

Dimenzija panela 900x2100mm; min. dim. 600x1620mm; Dimenzija polupanela 450x2100mm; min. dim. 290x1590mm



SV-LEA-DPH-4



SV-LEA-DPB-4



INXV-LEA-DPJ-4



SV-LEA-SPV-4 + P-SV-KIA-SPV

* Model Lea može biti lijevi i desni. Na slikama prikazan lijevi (pogled izvana). Obavezno navesti u narudžbi.

PROGRAM ELEGANT



SV-SAV-POT-2



SV-SAV-DPJ-2



SV-SAV-SPS-2



SV-SAV-DPR-2+P-SV-MIR-DPR

Dimenzija panela 900x2100mm; min. dim. 500x1600mm; Dimenzija polupanela 450x2100mm; min. dim. 290x1590mm



INXV-FLO-PFK-3



SV-FLO-DPJ-3



INXV-FLO-PLO-3 + P-INXV-KIA-PLO



SV-FLO-DPH-3

ELA

Dimenzija panela 900x1920mm; min. dim. 540x1560mm; Dimenzija polupanela 450x2100mm; min. dim. 270x1560mm



SV-ELA-FPK-3+P-MIA-FPK-3



INXV-ELA-PLO-3



INXV-ELA-MADRAS PAVÉ-3



INXV-ELA-DPR-3

Dimenzija panela 900x1920mm; min. dim. 510x1660mm; Dimenzija polupanela 450x2100mm; min. dim. 240x1660mm



SV-IVA-TOP



SV-IVA-DPJ



SV-IVA-DPL



SV-IVA-FPK + P-SV-PIA-FPK

DEA

Dimenzija panela 900x2100mm; min. dim. 700x1660mm; Dimenzija polupanela 450x2100mm; min. dim. 240x1660mm



INXV-DEA-DPH



SV-DEA-DPJ



INXV-DEA-PTB

**Staklo PTB nije dostupno u panelima debljine 24mm.*



SV-DEA-FKS + P-SV-PIA-FKS

Dimenzija panela 900x2100mm; min. dim. 550x1660mm; Dimenzija polupanela 450x2100mm; min. dim. 240x1660mm



SV-ANA-DPL-2



INXV-ANA-DPJ-2



SV-ANA-PMB-2 + P-SV-PIA-PMB

*Staklo PMB nije dostupno u (polu)panelima debljine 24mm.



SV-ANA-TOK-2

TEA

Dimenzija panela 900x2100mm; min. dim. 560x1560mm; Dimenzija polupanela 450x2100mm; min. dim. 270x1560mm



SV-TEA-DPH-3



SV-TEA-XLP-3+P-MIA-XLP-3



SV-TEA-DPL-3



INXV-TEA-DPZ-3



INXV-EVA-FPK-4



SV-EVA-PLF-4



SV-EVA-SPS-4



INXV-EVA-TOP-4



MON



O-MON

*Dimenzija panela 900x2100mm; min. dim. 550x1800mm
Aplikacija mora biti obostrana*



INOX-BOT-DPR



S-BOT-DPC



S-BOT-DPB



S-BOT-DPP

RENOIR

Dimenzija panela 900x2100mm; min. dim. 600x1700mm



REN-PFL-3



REN-DPL-3



REN-DPF-3



REN-SPM-3



GOY-FPK-5



GOY-DPZ-5



GOY-DPS-5



GOY-PFL-5

KLIMT

Dimenzija panela 900x2100mm; min. dim. 700x2000mm



KLI-FPK-3



KLI-DPR-3



KLI-DPJ-3



KLI-DPH-3



VER-DPZ



VER-DPF



VER-DPK



VER-DPL

DALI

Dimenzija panela 900x2100mm; min. dim. 600x1700mm



DAL-DPJ-4



DAL-DPF-4



DAL-DPZ-4



DAL-DPK-4



INXV-DEG-DPC



INXV-DEG-DPR



INXV-DEG-FPK



INXV-DEG-DPJ



HSG-B-IT-SPS



HSG-B-IT-DPH



HSG-B-IT-FPK



HSG-B-IT-PLM



HSG-B-CH-DPC-5



HSG-B-CH-DPL-5

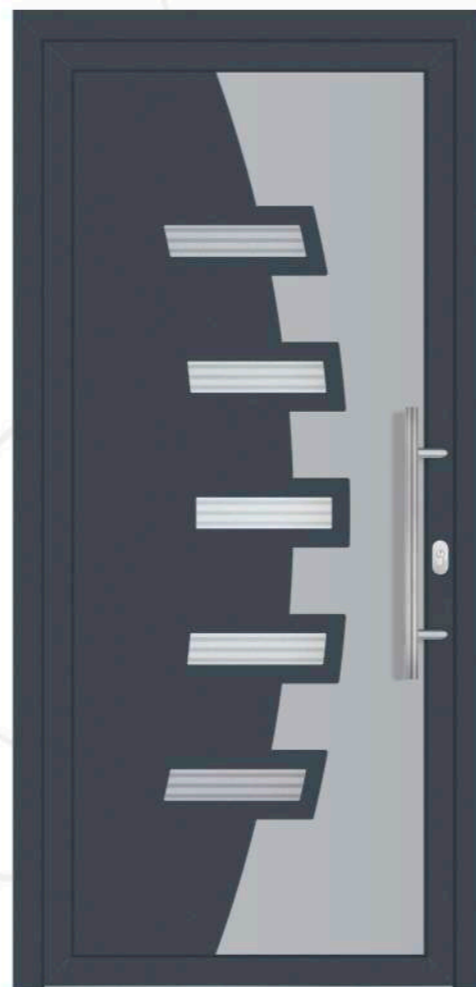

HSG-OK-CH-DPZ-5



HSG-B-CH-DPB-5



HSG-B-HU-PLS-4



HSG-B-HU-DPJ-4



HSG-B-HU-DPO-4



HSG-B-HU-PLM-4



HSG-B-DK-DPC-4



HSG-B-DK-DPL-4



HSG-B-DK-DPR-4



HSG-B-DK-FPK-4



HDR-B-NL-DPT-3



HSG-B-NL-PFL-3



HSG-B-NL-DPJ-3



HSG-B-NL-DPS-3

Dimenzija panela 900x2100mm; min. dim. 500x1560mm; Dimenzija polupanela 450x2100mm; min. dim. 320x1560mm



HSG-B-FR-SPF



HSG-B-FR-DPK



HSG-B-FR-PLS

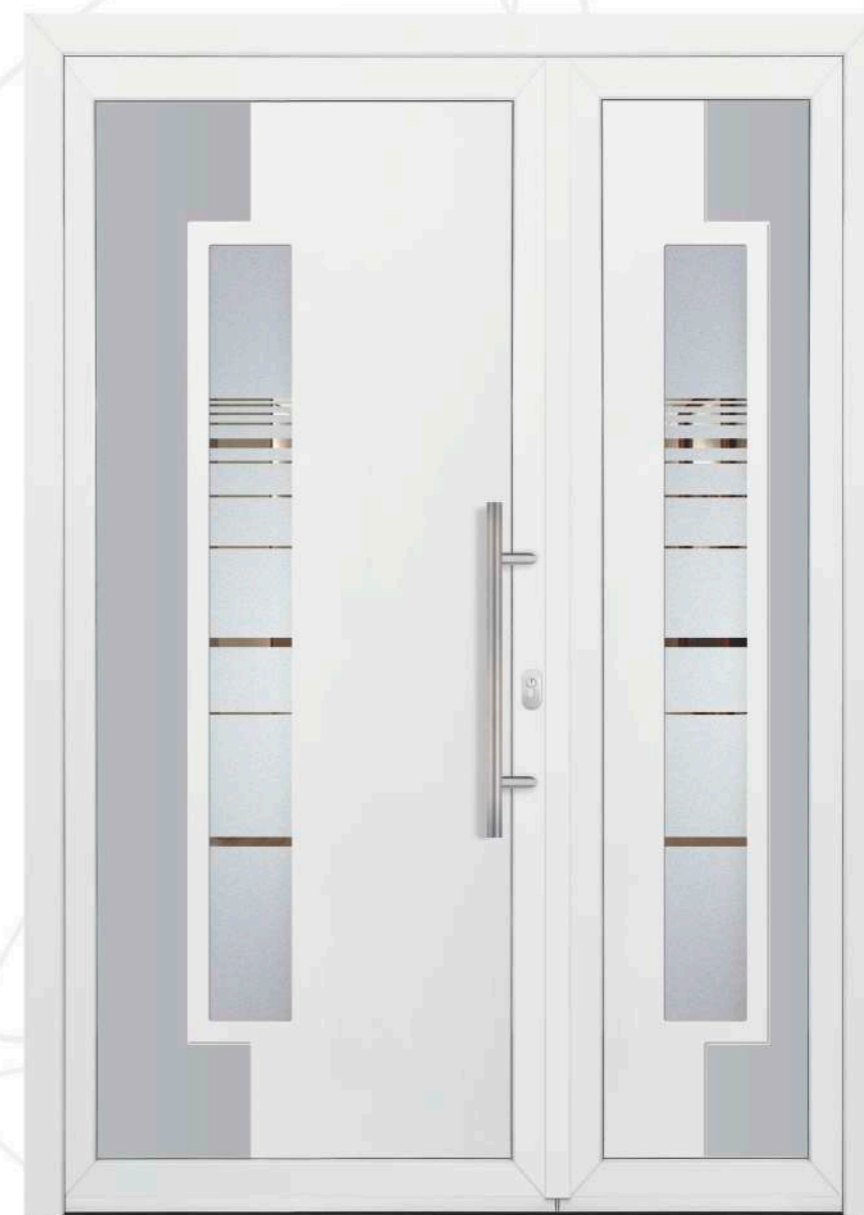

HSG-B-FR-DPH + P-HSG-B-FR-DPH

PLITVICE

Dimenzija panela 900x2100mm; min. dim. 560x1560mm; Dimenzija polupanela 450x2100mm; min. dim. 260x1550mm



HDB-INOX-PLI-DPL-4



HB-S-PLI-SPV-4 + P-HB-S-MOD-SPV



HRH-INOX-PLI-PFO-4



HBB-INOX-PLI-DPB-4

Dimenzija panela 900x2100mm; min. dim. 500x1560mm; Dimenzija polupanela 450x2100mm; min. dim. 260x1560mm

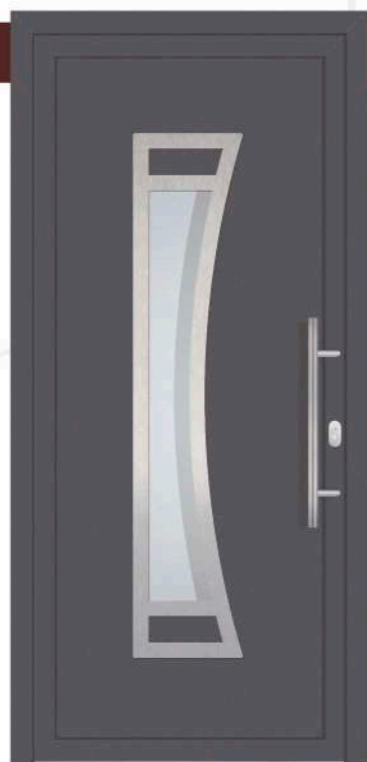

HDB-INOX-KOR-DPJ



HSW-S-KOR-SPS



HOK-S-KOR-PFL



HB-INOX-KOR-PLT + P-HB-INOX-KOR-PLT

BIOKOVO

Dimenzija panela 900x2100mm; min. dim. 500x1610mm; Dimenzija polupanela 450x2100mm; min. dim. 230x1610mm



HNS-INOX-BIO-TOK-3



HB-INOX-BIO-XLP-3 + P-HB-INOX-BIO-XLP-3



HBG-S-BIO-DPZ-3



HB-INOX-BIO-TOP-3

Dimenzija panela 900x2100mm; min. dim. 500x1500mm; Dimenzija polupanela 450x2100mm; min. dim. 260x1500mm



HB-S-VRS-FPK-4



HCA-INOX-VRS-OT-4+P-HCA-INOX-VRS-OT-4



HBG-S-VRS-MADRAS PAVÉ-4



HMM-INOX-VRS-PFM-4

DILJ

Dimenzija panela 900x2100mm; min. dim. 570x1550mm; Dimenzija polupanela 450x2100mm; min. dim. 260x1550mm



HB-S-DILJ-DPJ-2+P-HB-S-MOD-DPJ



HDB-INOX-DILJ-PFL-2



HRH-INOX-DILJ-TOP-2



HSB-INOX-DILJ-DPH-2

Dimenzija panela 900x2100mm; min. dim. 500x1550mm; Dimenzija polupanela 450x2100mm; min. dim. 260x1550mm

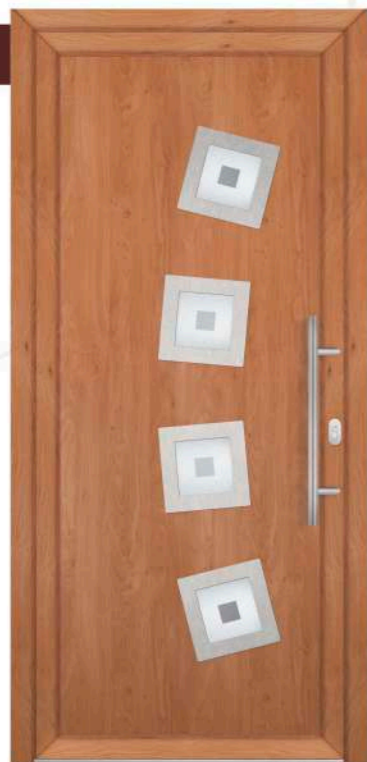

HWI-INOX-HVA-DPT-4



HB-S-HVA-DPH-4+P-HB-S-MOD-DPH



HSR-INOX-HVA-PFM-4



HQS-INOX-HVA-PLS-4

KALI

Dimenzija panela 900x2100mm; min. dim. 560x1550mm

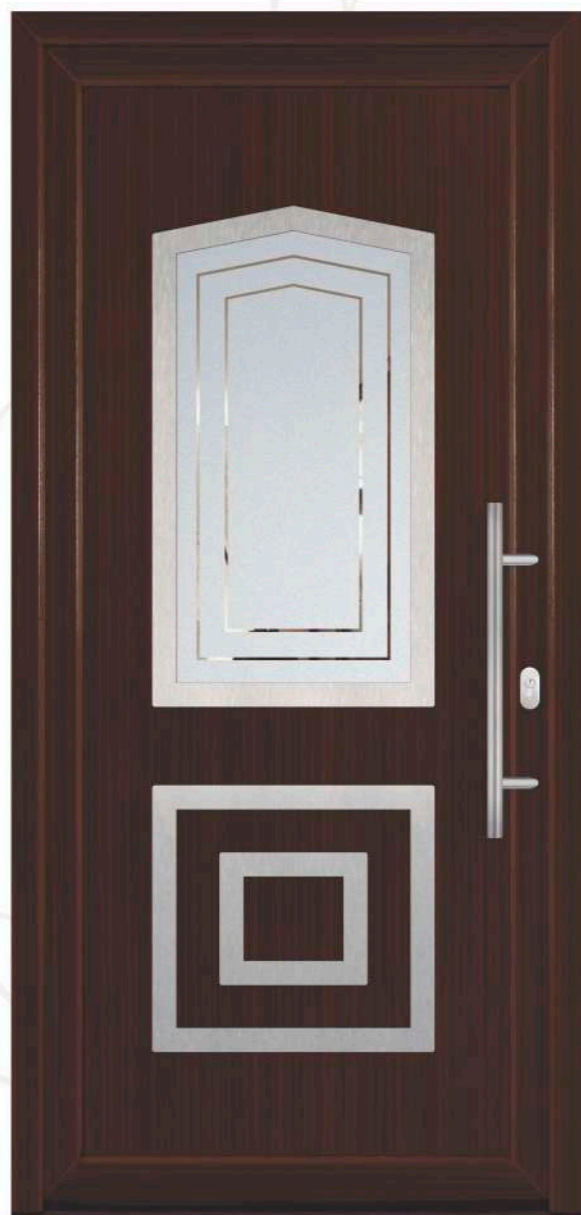

HM-INOX-KAL-DPH

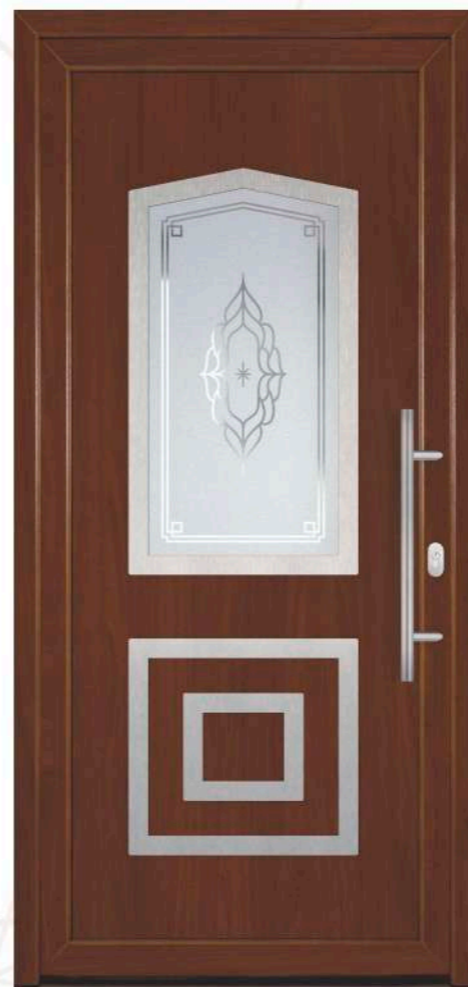

HNS-INOX-KAL-PZM



HOK-S-KAL-MADRAS UADI

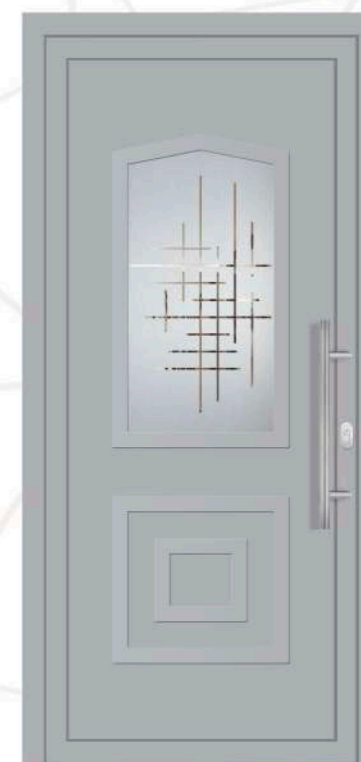

HSG-S-KAL-POL



HBO-S-ERD-PJ-4



HRH-INOX-ERD-DPH-4



HAK-INOX-ERD-TOP-4



HCW-INOX-ERD-SPS-4

OLIB

Dimenzija panela 900x2100mm; min. dim. 580x1540mm



HRH-INOX-OLI-DPH



HB-S-OLI-DPF



HOL-INOX-OLI-PTF



HSB-INOX-OLI-PZM

Dimenzija panela 900x2100mm; min. dim. 580x1510mm; Dimenzija polupanela 450x2100mm; min. dim. 260x1510mm



HDG-S-MUR-DPJ-2

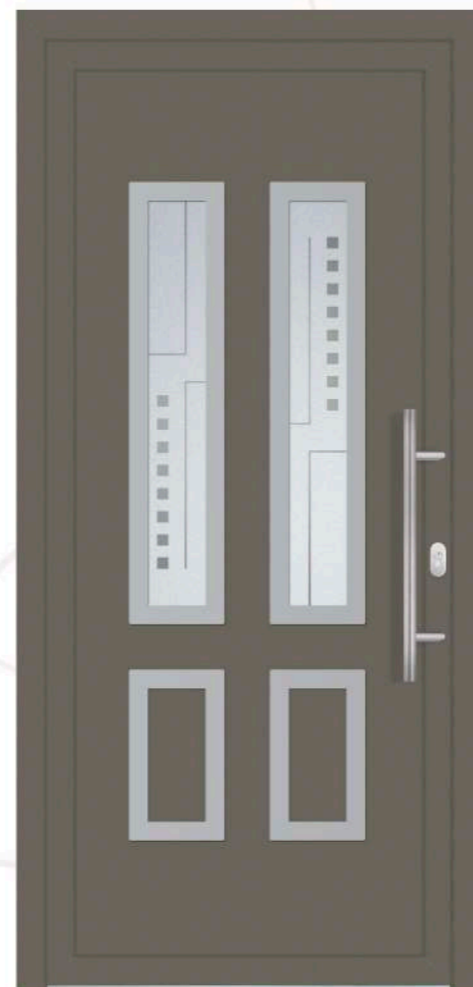

HQS-S-MUR-DPK-2



HSN-INOX-MUR-TOP-2



HO-S-MUR-DPR-2 + P-HO-S-MUR-DPR

MLJET

Dimenzija panela 900x2100mm; min. dim. 500x1610mm; Dimenzija polupanela 450x2100mm; min. dim. 260x1610mm

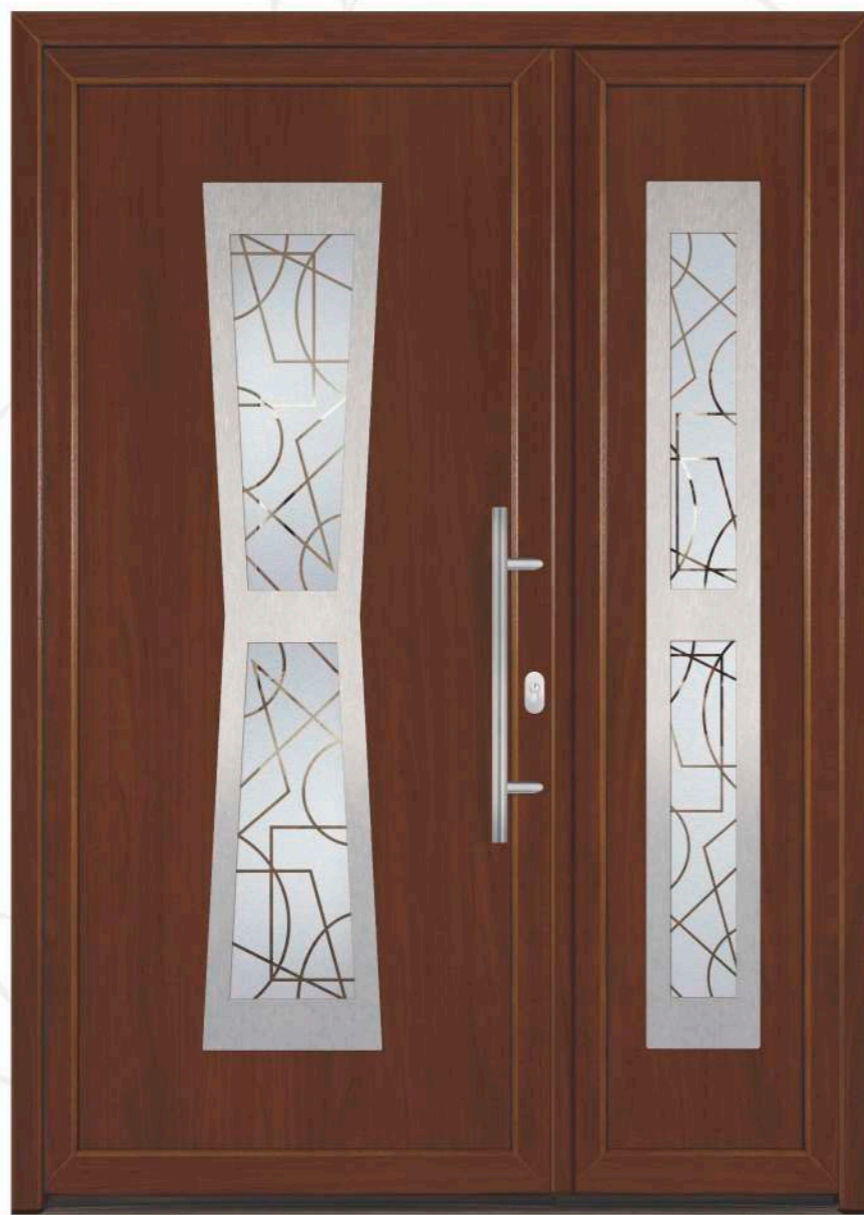

HNS-INOX-MLJE-SPS-2+P-HNS-INOX-MLJE-SPS-2



HBG-INOX-MLJE-DPK-2



HB-S-MLJE-DPJ-2



HWI-S-MLJE-DPL-2

Dimenzija panela 900x2100mm; min. dim. 500x1560mm; Dimenzija polupanela 450x2100mm; min. dim. 300x1560mm



HB-S-PAP-TOK-2



HOK-S-PAP-DPL-2



HO-INOX-PAP-FAB-2 + P-HO-INOX-PAP-FAB-2



HEH-INOX-PAP-SPS-2

BRIJUNI

Dimenzija panela 900x2100mm; min. dim. 500x1660mm; Dimenzija polupanela 450x2100mm; min. dim. 330x1660mm



HDB-INOX-BRI-PFM-4



HWI-S-BRI-MADRAS PAVÉ-4



HOK-S-BRI-SPL-4



HCA-INOX-BRI-PFO-4+P-HCA-INOX-BRI-PFO-4

Dimenzija panela 900x2100mm; min. dim. 500x1560mm; Dimenzija polupanela 450x2100mm; min. dim. 260x1560mm



HMH-INOX-MED-POT + P-HMH-INOX-MED-POT



HB-S-MED-SPS



HSP-S-MED-DPR



HZH-INOX-MED-PTB

PAKLENICA

Dimenzija panela 900x2100mm; min. dim. 570x1560mm; Dimenzija polupanela 450x2100mm; min. dim. 260x1560mm



HOK-INOX-PAK-TOP-4



HQS-S-PAK-DPR-4



HSK-S-PAK-FPK-4



HM-INOX-PAK-DPH-4 + P-HM-INOX-PAK-DPH-4

Dimenzija panela 900x2100mm; min. dim. 540x1560mm; Dimenzija polupanela 450x2100mm; min. dim. 280x1560mm



HBO-S-RIS-SPF-3



HZG-S-RIS-DPR-3



HMH-INOX-RIS-PFL-3 + P-HMH-INOX-RIS-PFL-2

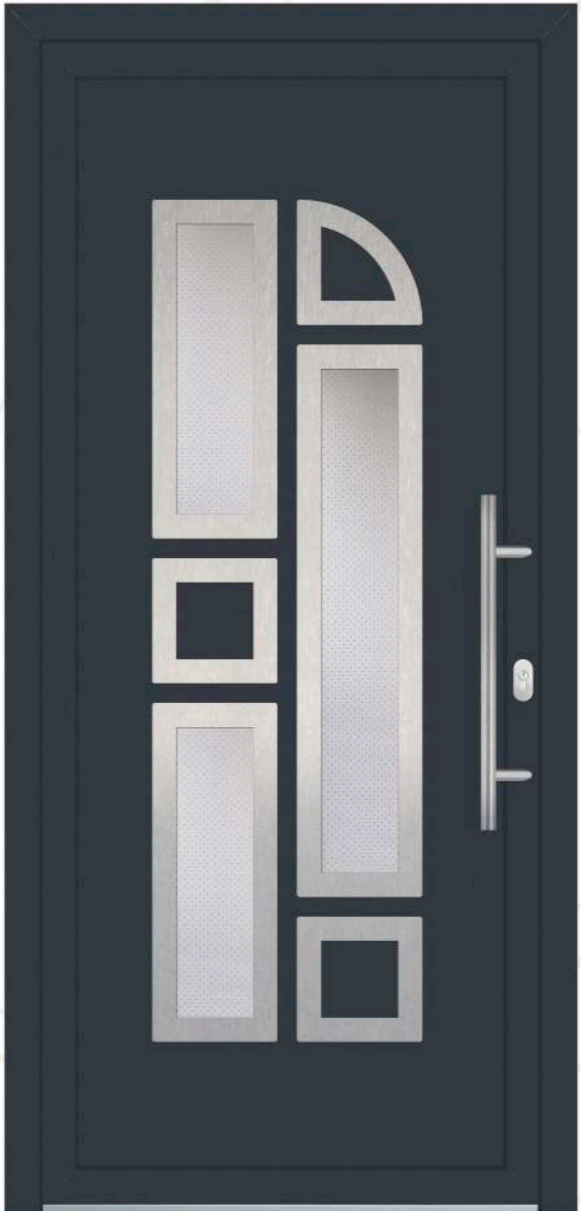

HAK-INOX-RIS-MADRAS PAVÉ-3

KOZJAK

Dimenzija panela 900x2100mm; min. dim. 500x1500mm



HDB-S-KOZ-DPJ



HCW-S-KOZ-SPF



HZH-INOX-KOZ-POT



HSW-INOX-KOZ-DPS

Dimenzija panela 900x2100mm; min. dim. 540x1550mm; Dimenzija polupanela 450x2100mm; min. dim. 260x1550mm



HPH-INOX-PSU-PGF



HB-S-PSU-DPH+P-HB-S-MOD-DPH



HQS-INOX-PSU-FPK



HOL-INOX-PSU-PKM

STON

Dimenzija panela 900x2100mm; min. dim. 500x1550mm; Dimenzija polupanela 450x2100mm; min. dim. 260x1550mm



HSTAHL-INOX-STO-DPJ-2



H0-INOX-STO-DPH-2



HPH-INOX-STO-POT-2



HB-S-STO-SPS-2+P-HB-S-MOD-SPS

Dimenzija panela 900x2100mm; min. dim. 500x1560mm; Dimenzija polupanela 450x2100mm; min. dim. 260x1550mm



HCA-INOX-VRA-PLO-3



HDG-INOX-VRA-POT-3



HB-S-VRA-DPJ-3+P-HB-S-MOD-DPJ



HSN-INOX-VRA-DPR-3

DVOR

Dimenzija panela 900x2100mm; min. dim. 520x1550mm; Dimenzija polupanela 450x2100mm; min. dim. 260x1550mm



HBG-INOX-DVO-PFL-1

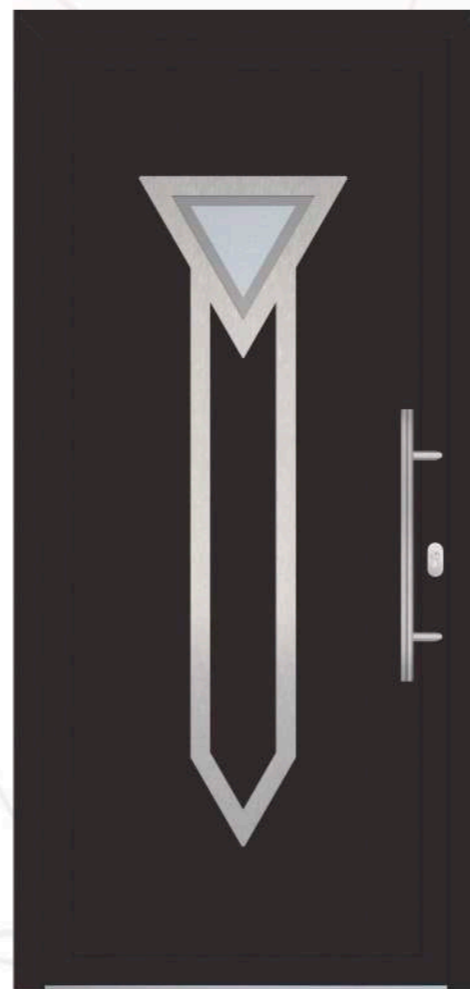

HSB-INOX-DVO-DPJ-1



HSD-S-DVO-SPP-1



HB-S-DVO-DPR-1+P-HB-S-MOD-DPR

Dimenzija panela 900x2100mm; min. dim. 550x1500mm; Dimenzija polupanela 450x2100mm; min. dim. 270x1500mm

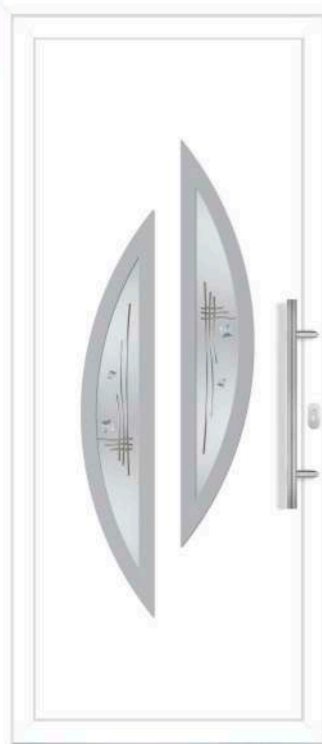

HB-S-KLE-PTB-2

**Staklo PTB nije dostupno u panelima debljine 24mm.*



HSP-INOX-KLE-FPK-2



HZH-INOX-KLE-MADRAS PAVÉ-2 + P-HZH-INOX-KLE-MADRAS PAVÉ



HO-INOX-KLE-DPH-2

KOPAČKI RIT

Dimenzija panela 900x2100mm; min. dim. 510x1560mm; Dimenzija polupanela 450x2100mm; min. dim. 260x1550mm

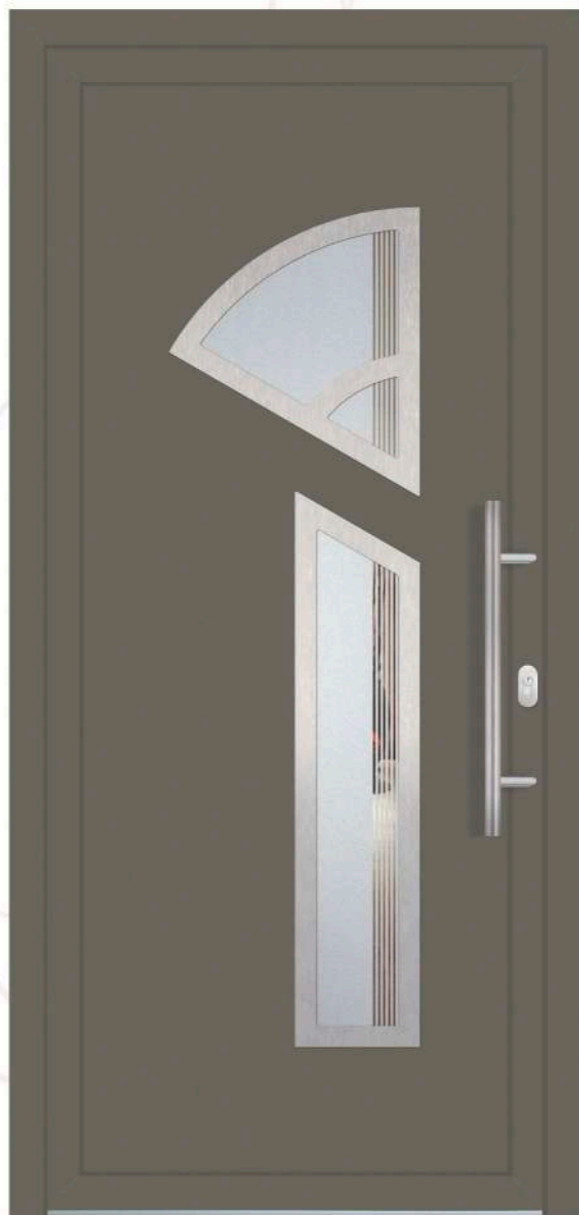

HQS-INOX-KOP-PFL-2



HRH-S-KOP-FPK-2+P-HRH-S-MOD-FPK



HEH-INOX-KOP-DPH-2



HWR-INOX-KOP-TOK-2

Dimenzija panela 900x2100mm; min. dim. 700x1600mm; Dimenzija polupanela 450x2100mm; min. dim. 260x1600mm



HO-INOX-GAL-DPF

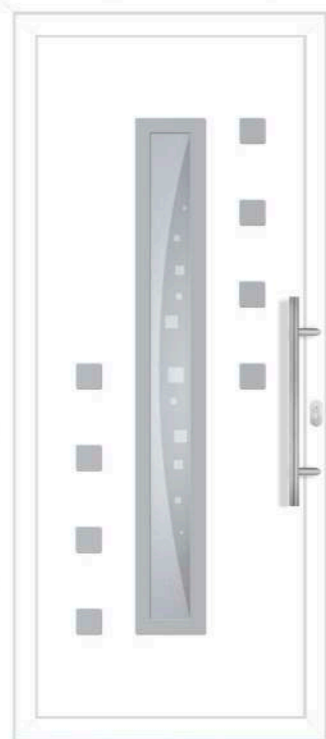

HB-S-GAL-DPJ

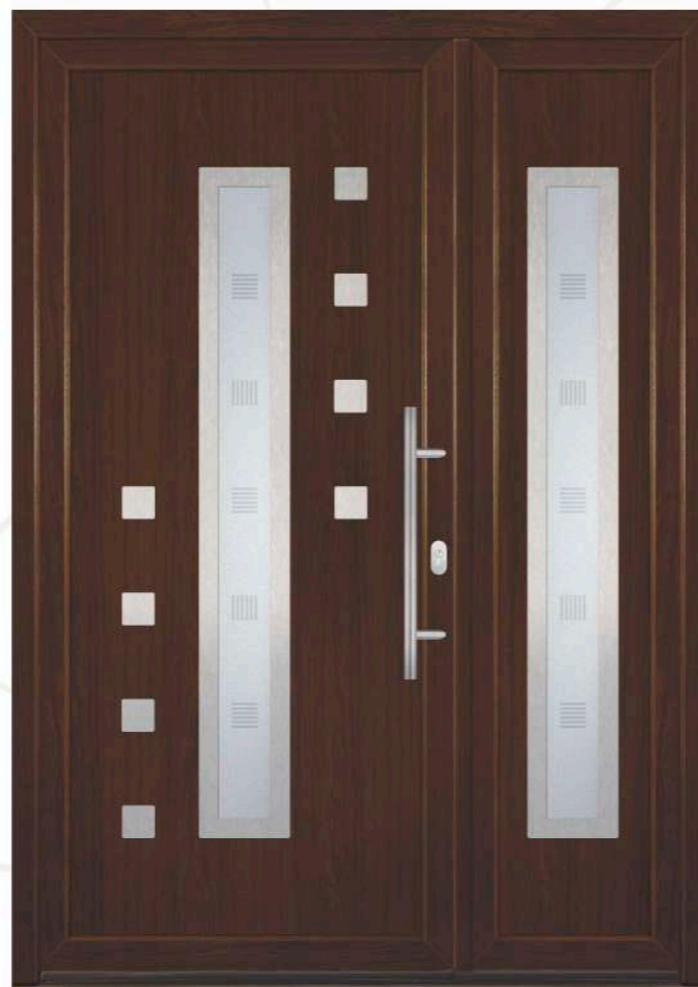

HMH-INOX-GAL-DPL + P-HMH-INOX-GAL-DPL

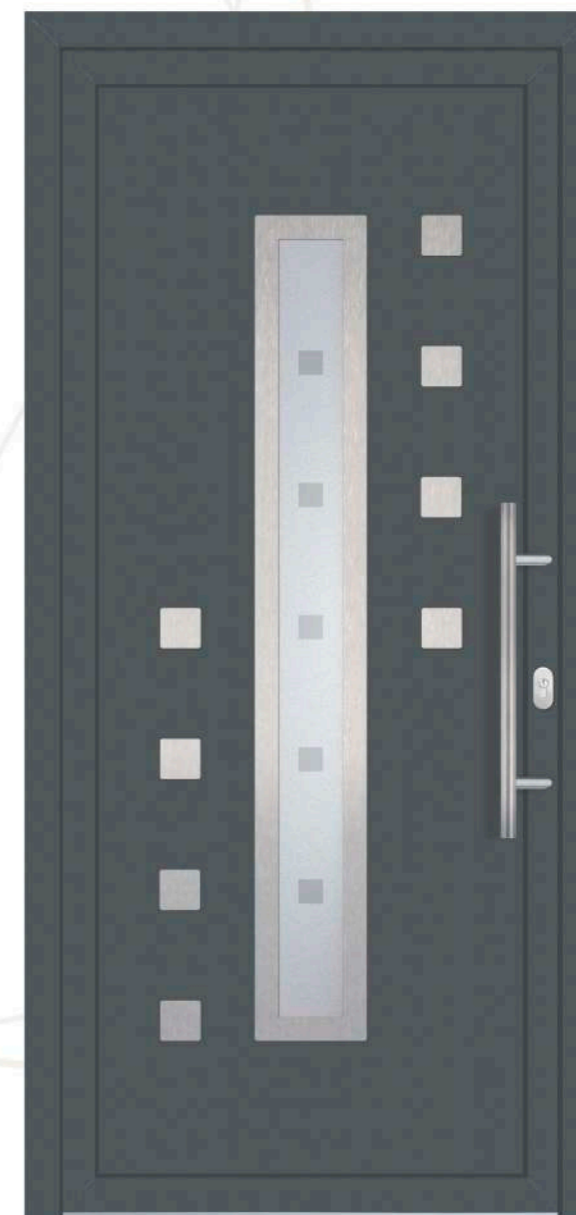

HBG-INOX-GAL-DPK

SKRADIN

Dimenzija panela 900x2100mm; min. dim. 500x1600mm; Dimenzija polupanela 450x2100mm; min. dim. 270x1600mm



HNS-INOX-SKR-FAB-3 + P-HNS-INOX-SKR-FAB-3

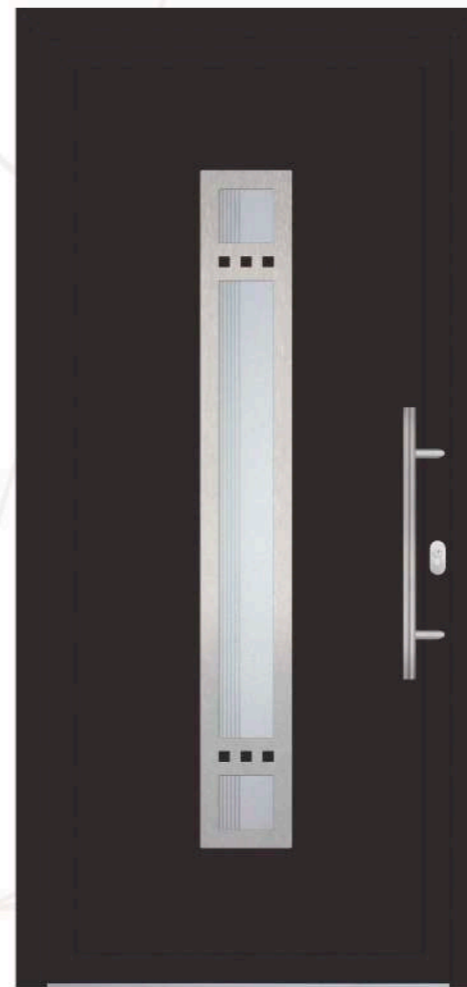

HSB-INOX-SKR-PLS-3



HSP-S-SKR-DPR-3



HSK-INOX-SKR-DPK-3

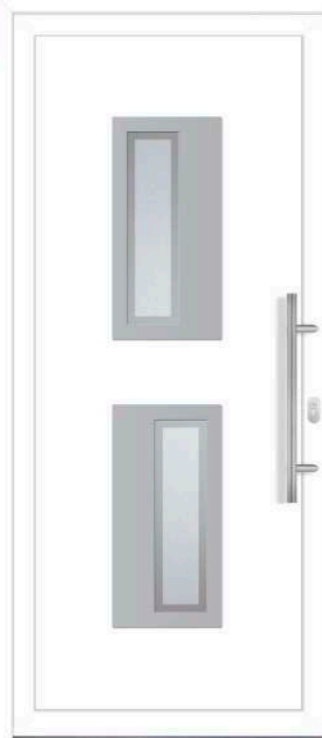

HB-S-JEZ-DPJ-2



HDG-INOX-JEZ-DPR-2



HO-INOX-JEZ-DPS-2

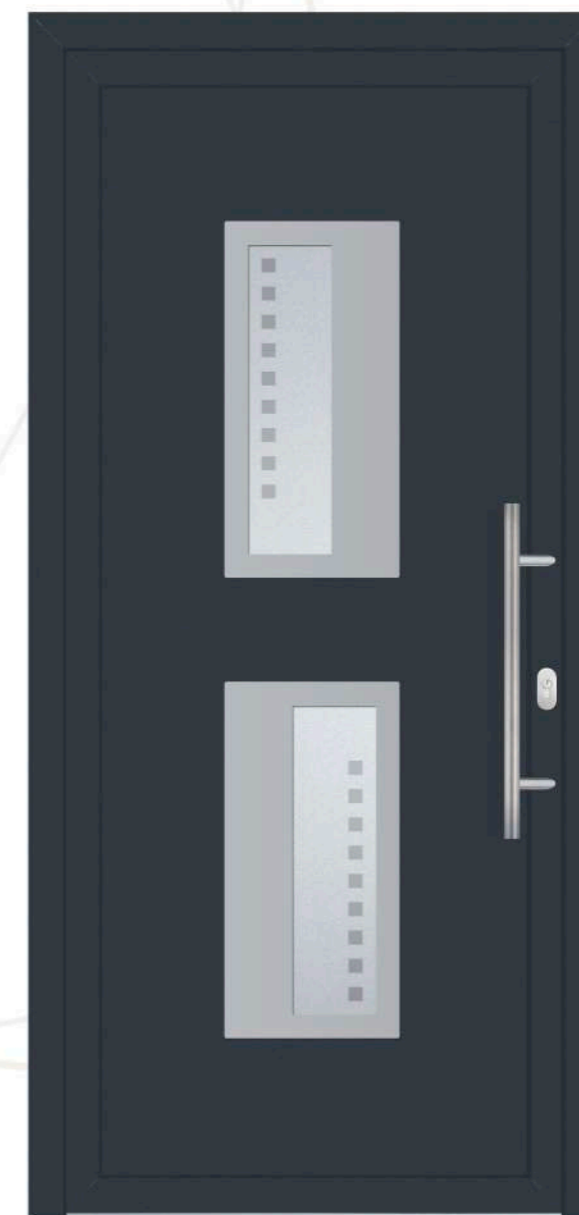

HAK-S-JEZ-DPZ-2

ŽUMBERAK

Dimenzija panela 900x2100mm; min. dim. 700x1700mm; Dimenzija polupanela 450x2100mm; min. dim. 270x1700mm

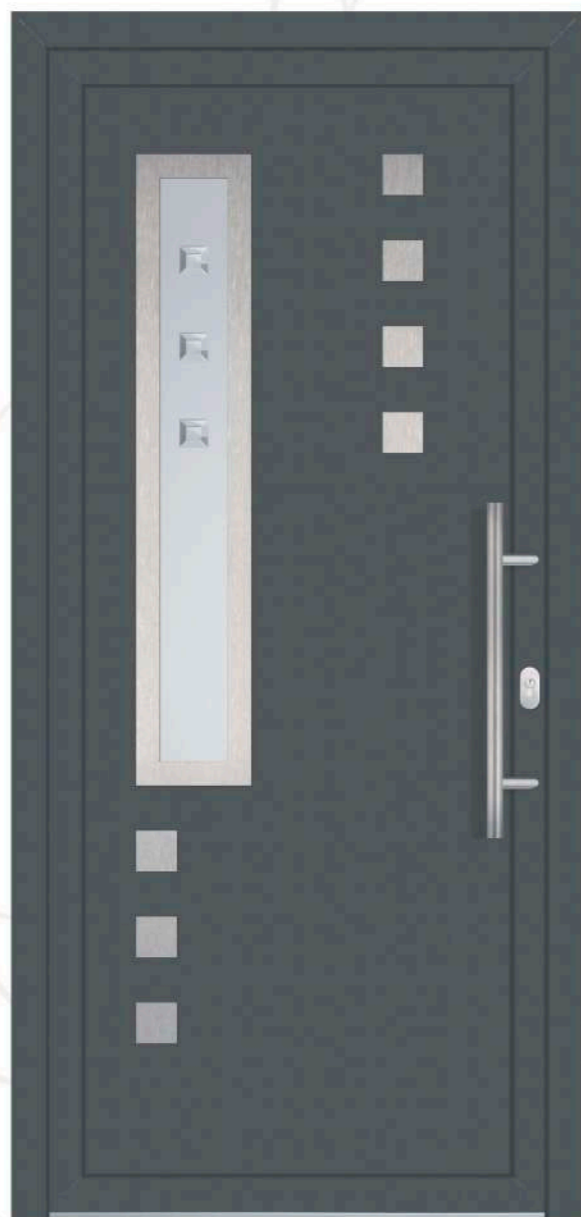

HBG-INOX-ŽUM-FAB

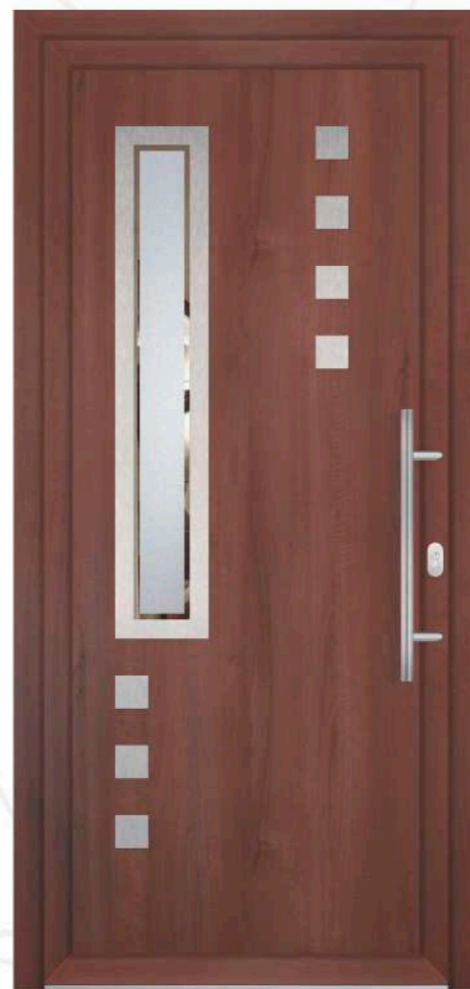

HSR-INOX-ŽUM-FPK

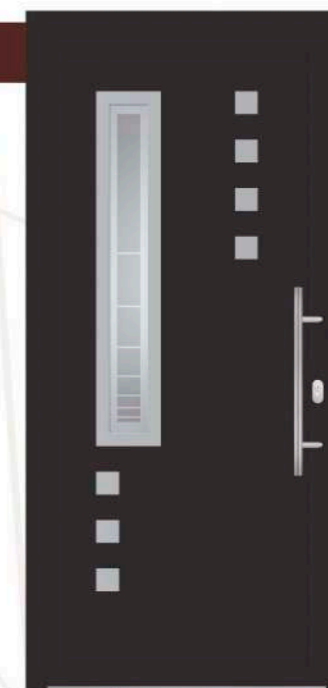

HSB-S-ŽUM-DPZ



HO-INOX-ŽUM-SPM + P-HO-INOX-ŽUM-SPM

Dimenzija panela 900x2100mm; min. dim. 500x1600mm; Dimenzija polupanela 450x2100mm; min. dim. 380x1600mm



HCW-S-JAN-DPO-2



HAK-S-JAN-DPL-2



HBO-INOX-JAN-FAB-2 + P-HBO-INOX-JAN-FAB-2



HO-INOX-JAN-DPK-2

TELAŠČICA

Dimenzija panela 900x2100mm; min. dim. 500x1600mm; Dimenzija polupanela 450x2100mm; min. dim. 260x1600mm



HRC-INOX-TEL-PFL

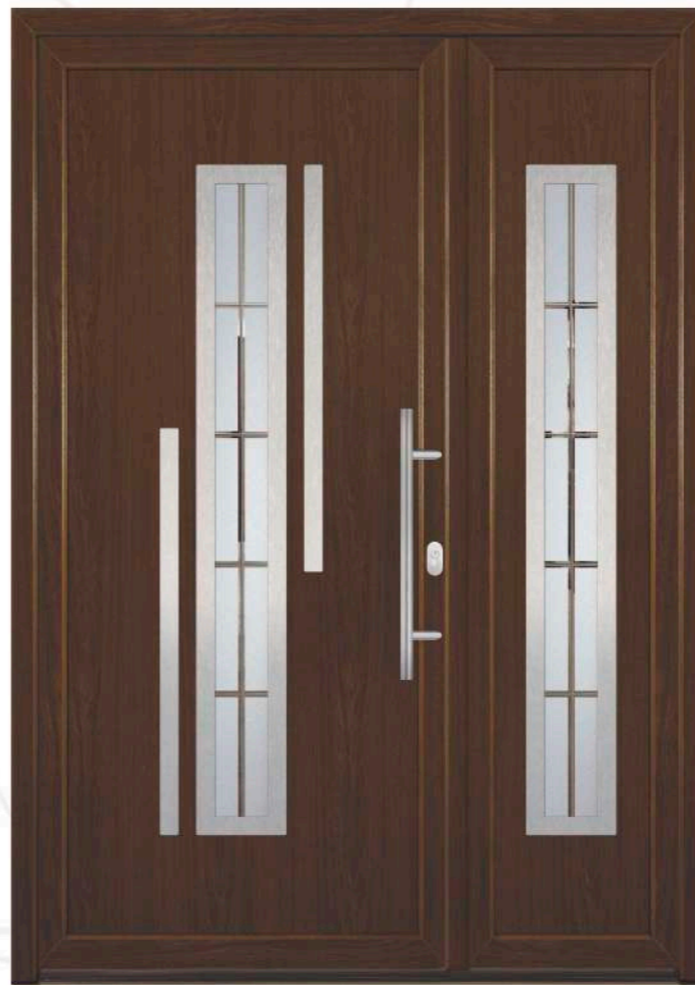

HRH-INOX-TEL-POT + P-HRH-INOX-TEL-POT



HDR-S-TEL-DPH



HEH-S-TEL-SPF

Dimenzija panela 900x2100mm; min. dim. 500x1600mm; Dimenzija polupanela 450x2100mm; min. dim. 270x1600mm

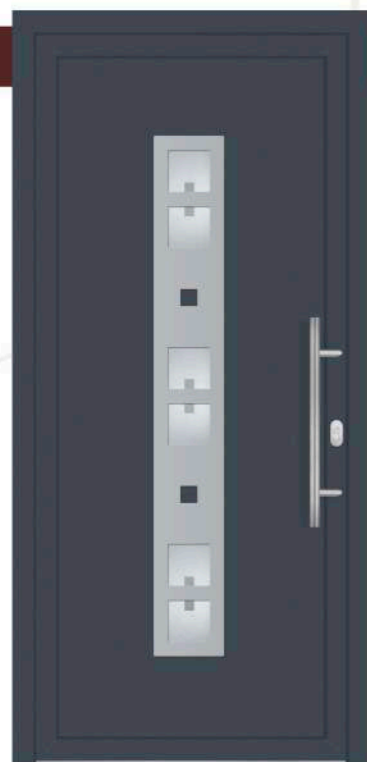

HOK-S-LAS-DPR-6



HCW-S-LAS-DPH-6



HDB-INOX-LAS-PFL-6



HB-INOX-LAS-MADRAS PAVÉ-6 + P-HB-INOX-LAS-MADRAS PAVÉ-6

LONJA

Dimenzija panela 900x2100mm; min. dim. 500x1800mm; Dimenzija polupanela 450x2100mm; min. dim. 350x1800mm



HBO-S-LONJ-FPK-3



HB-S-LONJ-DPJ-3



HDB-INOX-LONJ-DPC-3



HZH-S-LONJ-DPH-3 + P-HZH-S-LONJ-DPH-3

Dimenzija panela 900x2100mm; min. dim. 600x1600mm; Dimenzija polupanela 450x2100mm; min. dim. 260x1600mm



HZH-INOX-RAS-DPR-2



HSD-S-RAS-PLS-2



HWI-S-RAS-DPF-2



HNS-INOX-RAS-PLM-2 + P-HNS-INOX-RAS-PLM-2



- ① STAKLO
- ② HPL BOJE
- ③ PVC-ABS BOJE
- ④ APLIKACIJE
- ⑤ DODATCI



MOGUĆNOST UGRADNJE PANELOVA I TOLERANCIJA DIMENZIJA

PVC panel se može ugraditi u sva vrata izrađena iz standardnih PVC ili AL profila za ulazna vrata. Tolerancija u debljini panela +/- 1mm. Kod rezanja panela na mjeru - dopušteno odstupanje po visini i širini je do +/- 3 mm.

OSNOVNI SENDVIČ PANELOVI (OS) - 24, 36 ili 40mm dekorativni i ravni paneli - PVC, ALU ili HPL sastoje se iz dvije PVC, ALU ili HPL ploče između kojih je zalijepljen ekstrudirani polystyrol (izolacija).



STANDARDNO OJAČAN SENDVIČ PANELOVI (SO) - 24, 36 ili 40mm dekorativni i ravni paneli - PVC, ALU ili HPL sastoje se iz dvije PVC, ALU ili HPL ploče između kojih je zalijepljen ekstrudirani polystyrol (izolacija) ojačan PVC pločom kao izolacijom i ojačanjem panela.



Pri naručivanju panela obvezno upisati debljinu panela. U suprotnom isporučit će se panel u debljini 24mm.



SL-VFB-8+P-SL-VFB-4

SL - naziv panela
 VFB - naziv (oznaka) stakla
 8 - broj stakala
 +
 P-SL - oznaka za polupanel
 VFB - naziv (oznaka) stakla
 4 - broj stakala



INXV-HUM-DPR-4

INXV - INOX aplikacija (V znači vanjska)
 HUM - naziv panela
 DPR - naziv (oznaka) stakla
 4 - broj stakala



BAR-FM-F4-S+P-SRI-BA-4-S

BAR - naziv panela
 FM-F4 - naziv (oznaka) stakla
 S - srebrna traka
 +
 P-SRI - naziv polupanela
 BA-4 - naziv modela i stakla
 S - srebrna traka



HSG-B-FR-DPH+P-HSG-B-FR-DPH

HSG - HPL siva aplikacija
 B - PVC bijeli
 FR - naziv panela
 DPH - naziv (oznaka) stakla
 +
 P - oznaka polupanela
 HSG - HPL siva aplikacija
 B - PVC bijeli
 FR - naziv panela
 DPH - naziv (oznaka) stakla



HNS-INOX-MLJE-SPS-2+P-HNS-INOX-MLJE-SPS-2

HNS - HPL Noce sorento balsamico
 INOX - INOX aplikacija
 MLJE - naziv panela
 SPS - naziv (oznaka) stakla
 2 - broj stakala
 +
 P - oznaka polupanela
 HNS - HPL Noce sorento balsamico
 INOX - INOX aplikacija
 MLJE - naziv panela
 SPS - naziv (oznaka) stakla
 2 - broj stakala



INXO-EVA-FPK-4

INXO - INOX aplikacija (O znači obostrana)
 EVA - naziv panela
 FPK - naziv (oznaka) stakla
 4 - broj stakala

Pri naručivanju troslojnog stakla obvezno upisati kraticu 3G. Pri naručivanju troslojnog sigurnosnog stakla obvezno upisati kraticu VSG.

Ornament staklo



Satinato - PJ



DM



ČB

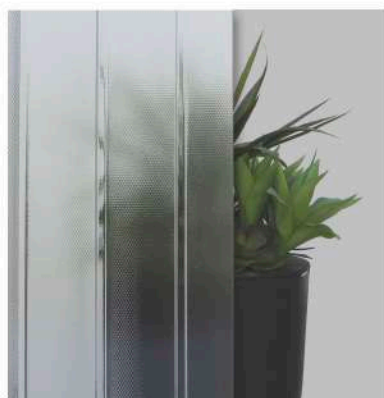

ML



DK



AB



MK



DS



AS

Dekoratívna stakla



STAKLO S UKRASNOM LETVICOM - Između stakala nalazi se ukrasna letvica zlatna, srebrna ili bijela. Nisu dostupne u troslojnom staklu.



STAKLO S FAZETOM - unutarne staklo je satinato, na koje je nalijepljena fazeta.



DEKORATIVNO PJEKARENO STAKLO S FAZETOM - unutarne staklo je pjeskareno, na koje je nalijepljena fazeta.



DEKORATIVNO PJEKARENO STAKLO S OLOVNOM TRAKOM - unutarne staklo je pjeskareno, na koje je nalijepljena olovna traka.



DEKORATIVNO VITRAJ STAKLO S FOLIJOM - unutarnje staklo je ornament (katedral ili satinato) s nalijepljenom folijom - 5 boja i obostrano obrubljeno olovnom trakom.



DEKORATIVNO VITRAJ STAKLO S FAZETOM - unutarnje staklo je satinato, na koje je nalijepljena fazeta i obostrano obrubljeno olovnom trakom.



DEKORATIVNO VITRAJ STAKLO S FAZETOM I FOLIJOM - unutarnje staklo je satinato, na koje je nalijepljena fazeta na rubovima je folija - 5 boja i obostrano obrubljeno olovnom trakom.



MADRAS UADI



DEKORATIVNO PJESKARENO STAKLO - na unutarnjem satinato staklu ispjescareni su različiti motivi.

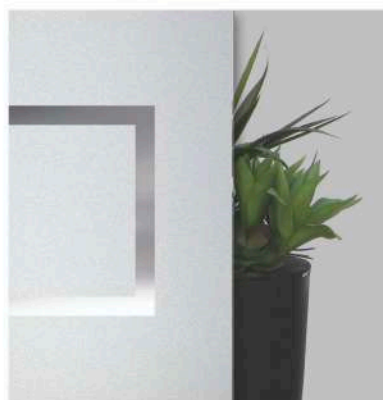

PJESKARENO ZRCALO - unutarnje staklo je pjescareno zrcalo s raznim motivima.

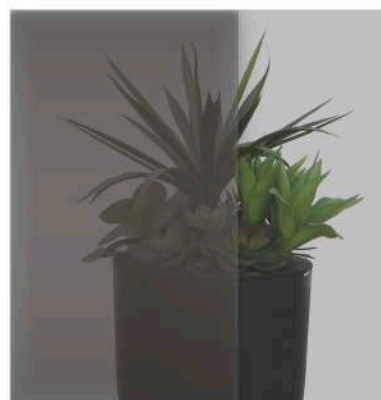

PARSOL SIVI



MADRAS PAVÉ

Paneli iz svih programa dostupni su u izvedbama i s dvoslojnim i s troslojnim staklom, osim panela (PAN i BAR) i polupanela (P-SRI) iz programa Exclusiv koji su dostupni samo s troslojnim staklom.

- float obostrano + srednje (sve iz naše ponude) - **3G** ili

- VSG (samo unutra ili obostrano) + srednje (sve iz naše ponude) - **VSG 33.1** ili **VSG/O**

STANDARDNA IZRADA DVOSLOJNOG IZO STAKLA -

vanjsko staklo float, a unutarnje staklo ornament ili dekorativno staklo (slika 1)



Pri narudžbi panela s troslojnim staklom - obavezno upisati kraticu **3G**

Pri narudžbi panela s troslojnim sigurnosnim staklom - obavezno upisati kraticu **VSG** (to podrazumijeva da je VSG 33.1 s unutarnje strane panela).

Pri narudžbi panela s troslojnim sigurnosnim VSG staklom - obostrano - obavezno upisati kraticu **VSG/O**.

STANDARDNA IZRADA TROSLOJNOG STAKLA -

vanjska stakla obostrano float (slika 2) ili

vanjsko staklo float, a unutarnje sigurnosno VSG 33.1 staklo (slika 3).

Srednje staklo u obje opcije je ornament ili dekorativno staklo

3G

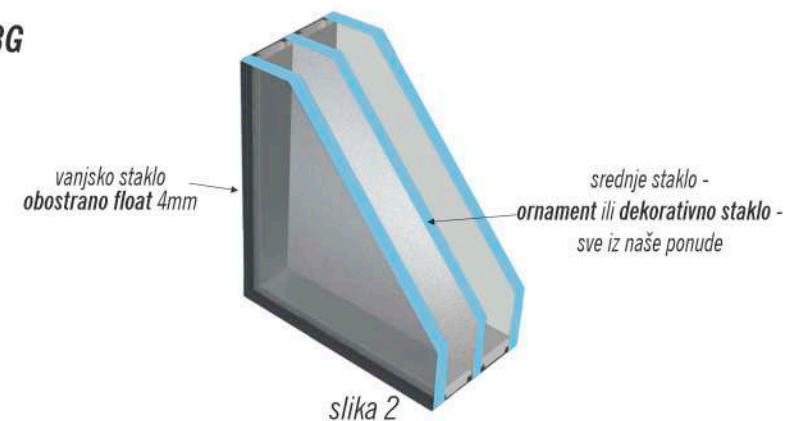

VSG 33.1

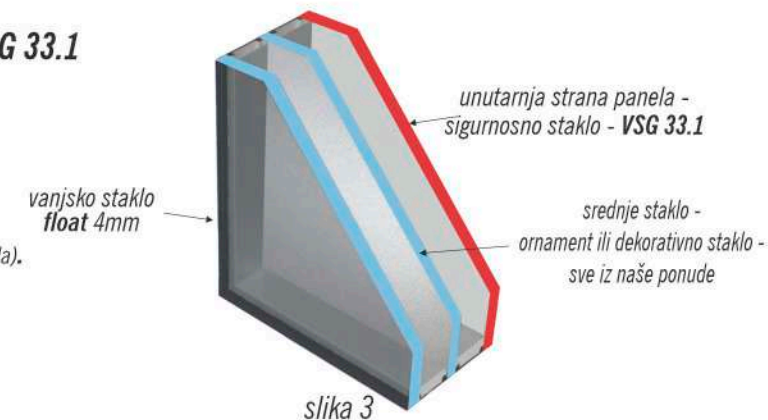

Minimalna debljina panela s troslojnim staklom - obostrano float - mora iznositi 32mm.

Minimalna debljina panela s troslojnim staklom - obostrano VSG 33.1 - mora iznositi 38mm.

Na zahtjev kupca možemo izraditi panel tanji od naših preporuka, ali u tom slučaju ne prihvaćamo reklamacije.

Za sitne tvorničke nepravilnosti proizvođača stakla - anomalije na staklu koje nisu vidljive s udaljenosti 2m od panela - ne prihvaćamo reklamaciju.



WHITE OPAQUE - HB
845



SIVA - HSG
RAL 9006



ZELENA - HZG
RAL 6005

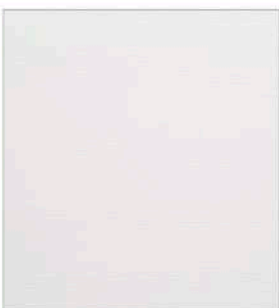

BRILLIANT WEISS - HBI
F 456 5057



ALT WEISS - HAW
456 5053



CREMEWEISS - HCW
137 905-167



BEIGE - HBE
F 436 5015



METBRUSH ALUMINIUM - HMB
F 436 1001



SILVER - HSI
F 436 1002

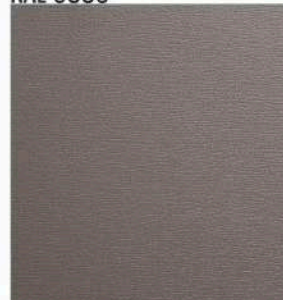

QUARTZ PLATINUM - HQP
1293 002-195

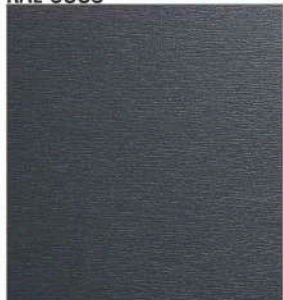

CROWN PLATINUM - HCP
1293 001-195



EARL PLATINUM - HEP
1293 010-195



ALUX DB 703 - HDB
F436 1014



SIGNALGRAU GLATT - HSK
7004 05 083



TITANIUM SFTN - HTS
F436-7049



SILBERGRAU - HSW
715 505-167



BASALTGRAU - HBG
701 205-167

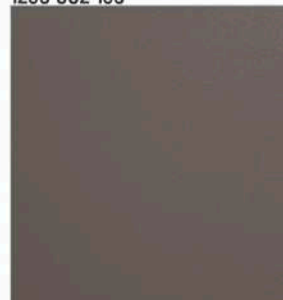

QUARTZGRAU SAND - HQS
F 436 7047



QUARTZGRAU WOOD - HQW
7039 05-167



SCHIEFERGRAU - HOK
7015 05-083



SCHIEFERGRAU - HSFG
7015 05-167

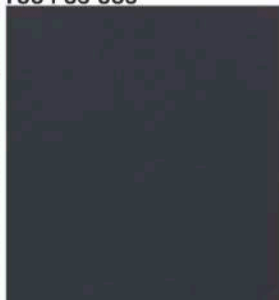

ANTHRAZITGRAU ULTI MAT - HAUM
02.20.71.000001-504700



ANTHRAZITGRAU - HAK
701 605-083



ANTHRAZITGRAU MATT - HAM
F 436 6003



ANTHRAZITGRAU - HAG
701 605-167



ANTHRAZITGRAU STYLO - HAS
F436 4003



RUBINROT - HRR
300 305-167



DUNKEL ROT - HDR
308 105-167



WEINROT - HWR
300 505-167



STAHLBLAU - H STAHL
515 005-167



MOOSGRÜN - HMG
6005 05-167



TAMNO ZELENA - HDG
612 5205-167

							
SCHOKOBRAUN - HSB 88 7505-167	PALISANDER - HPA 851 805-167	JET BLACK - HJB F 446 7062	SHEFFIELD OAK LIGHT - HOL F 456 3081	PRIRODNI HRAST - HPH 311 8076-168	SVIJETLI HRAST - HEH 205 2090-167	ZLATNI HRAST - HZH 217 8001-167	STAUFEREICHE KOLONIAL - HCH F 436 2036
							
SHERWOOD G - HWG 49158	HRAST MOCCA - HEM F 436 2075	RUSTIK HRAST - HRH 314 9008-167	MOCVARNI HRAST - HMH 205 2089-167	MONTANA HRAST TABAK - HET F 436 2007	TAMNI HRAST - HTH 214 0006-167	MOOREICHE - HME 316 7004-167	SHOGUN MONTANA - HSM 49197
							
SHOGUN AF - HSF 49198	SHOGUN AD - HSD 49195	BERGKIEFER - HBB F 306 9041-167	OREGON - HOG 211 5008-167	BOR - HBO 315 2009-167	WINCHESTER XA - HWI 492 40	NEWCASTLE OAK - HNO F 436 3077	SIENNA PL - HSP 49254
							
SIENA ROSSO - HSR 49 233	SIENA NOCE - HSN 49 237	NOCE SORRENTO NAT - HNP F 436 3041	WALNUSS AMARETTO - HWA F 436 3058	NOCE SORRENTO BAL - HNS F 436 3042	RUSTIK CHERRY - HRC 321 4007-195	CHERRY AMARETTO - HCA F 436 2043	SOFT CHERRY - HSC 321 4009-195

HPL BOJE I DRVNI DEKORI



BLACK CHERRY - HBC
320 2001-167

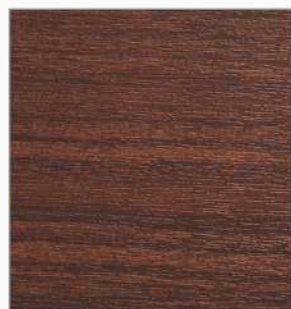

MACORÉ - HMC
316 2002-167



MAHAGONIJ - HM
209 7013-167



SAPELI - HSA
206 5021-167

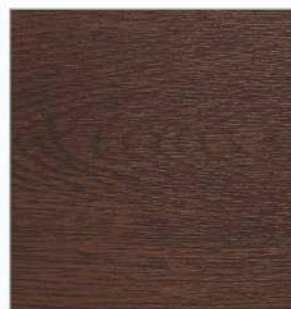

ORAH V - HO
217 8007-167



ORAH A - HOA
217 8005-167

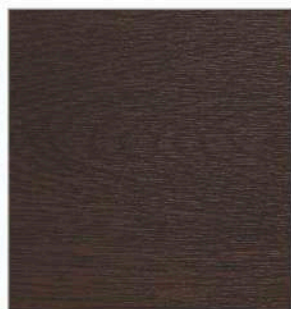

STAUFEREICHE TERRA - HSH
F 436 2035

PVC - ABS BOJE I DRVNI DEKORI

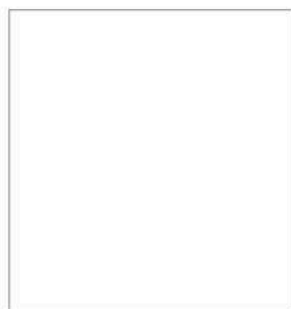

VEKA BIJELA - C 152



BEIGE - BE 7548 004WG



SIGNALGRAU - SK 700 405-083



SILBERGRAU - SW 8514 1004

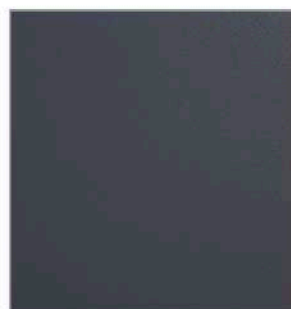

SCHIEFERGRAU - OK 701 505-083



ANTHRAZITGRAU - AG F 436 5003



ANTHRAZITGRAU - AK 8546



WINCHESTER XA - WI 492 40



BOR - BO 315 2009

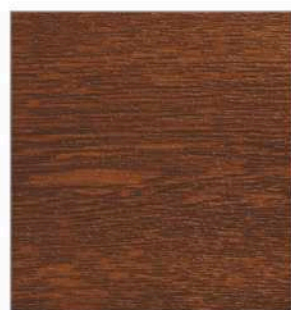

ZLATNI HRAST - ZH 217 8501

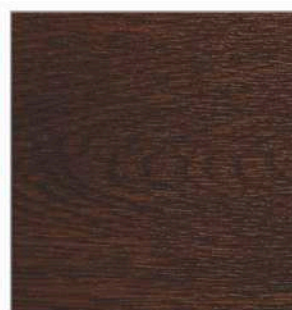

ORAH - O 217 8507

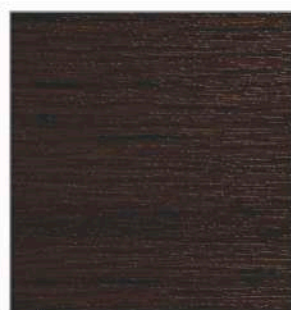

MOČVARNI HRAST - MH 205 2589



SAPELI - SA 206 5521



MAHAGONIJ - M 209 7513

ODRŽAVANJE I NJEGA INOX-a

Da bi održali panel lijepim i zaštili ga - za održavanje treba koristiti pH neutralna sredstva.
Nikako ne koristiti sredstva koja nisu namijenjena za održavanje INOX-a - abrazivna sredstva ili sredstva s agresivnim komponentama.

ALUMINIJ STANDARDNI IZBOR BOJA

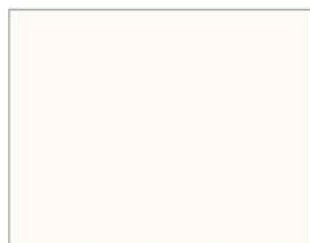

BIJELI ALUMINIJ - ALB RAL 9016 MAT

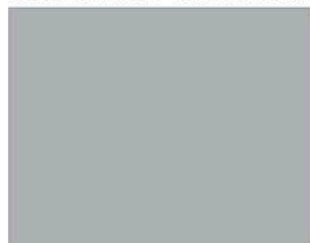

SIVI ALUMINIJ - ALS RAL 9006



ZELENI ALUMINIJ - ALZ RAL 6005

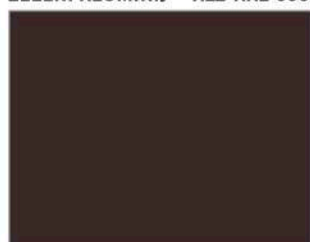

SMEĐI ALUMINIJ - ALSM RAL 8017



PUNTO GRIGIO - ALPG

APLIKACIJE



SIVA APLIKACIJA - S RAL 1597



CRVENA APLIKACIJA - C RAL 3061



PLAVA APLIKACIJA - P RAL 5013

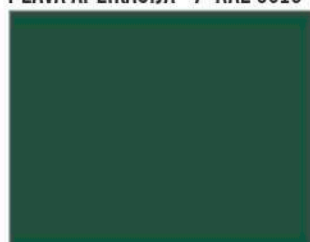

ZELENA APLIKACIJA - Z RAL 5081



ČEŠLJANI INOX

RUKOHVATI - KUT UGRADNJE 45°



POLIRANI

ČEŠLJANI

OPS 550	OCS 550	550mm
OPS 750	OCS 750	750mm
OPS 950	OCS 950	950mm
OPS 115	OCS 115	1150mm
OPS 160	OCS 160	1600mm
OPS 190	OCS 190	1900mm



POLIRANI

ČEŠLJANI

KPS 550	KCS 550	550mm
KPS 750	KCS 750	750mm
KPS 950	KCS 950	950mm
KPS 115	KCS 115	1150mm
KPS 160	KCS 160	1600mm
KPS 190	KCS 190	1900mm

RUKOHVATI - ZAOBLJENI I RAVNI - KUT UGRADNJE 90°



DODATCI



URNA ZLATNA ILI SREBRNA



ZURILO



BIJELI



SREBRNI

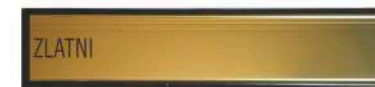

ZLATNI

POŠTANSKI SANDUČIĆ

POLUPANEL ŽUPANJA I PARAPETI



P-ŽU
dimenzija 900x960mm
min. dimenzija 560x560mm



P-RH
dimenzija 900x2100mm
min. dimenzija 500x1500mm



P-RV
dimenzija 900x1920mm
min. dimenzija 500x1500mm

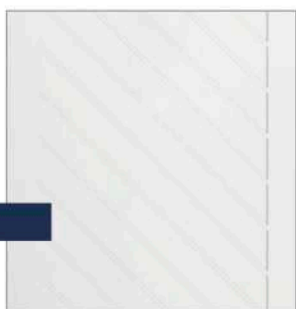

P-RK
dimenzija 900x1920mm
min. dimenzija 500x1500mm

RAVNE SENDVIČ PLOČE

RAVNE SENDVIČ PLOČE - bijele

dimenzija 1000x2000x20mm ili 24mm
dimenzija 1500x3000x20mm ili 24mm
dimenzija 2030x3000x20mm ili 24mm
dimenzija 1000x2000x36mm
dimenzija 1500x3000x36mm
dimenzija 2030x3000x36mm
dimenzija 1000x2000x40mm
dimenzija 1500x3000x40mm
dimenzija 2030x3000x40mm

RAVNE SENDVIČ PLOČE - bijelo-boja i boja-boja

dimenzija 975x2175x20mm
dimenzija 975x2175x24mm
dimenzija 975x2175x36mm
dimenzija 975x2175x40mm

ALU RAVNE SENDVIČ PLOČE

dimenzija 900x2100x20 mm
dimenzija 900x2100x24 mm
dimenzija 900x2100x36 mm
dimenzija 900x2100x40 mm

HPL RAVNE SENDVIČ PLOČE

dimenzija 900x2150x24 mm
dimenzija 900x2150x36 mm
dimenzija 900x2150x40 mm

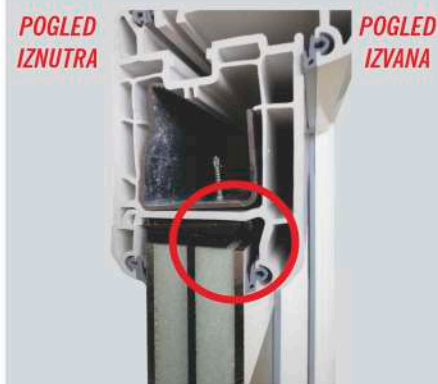
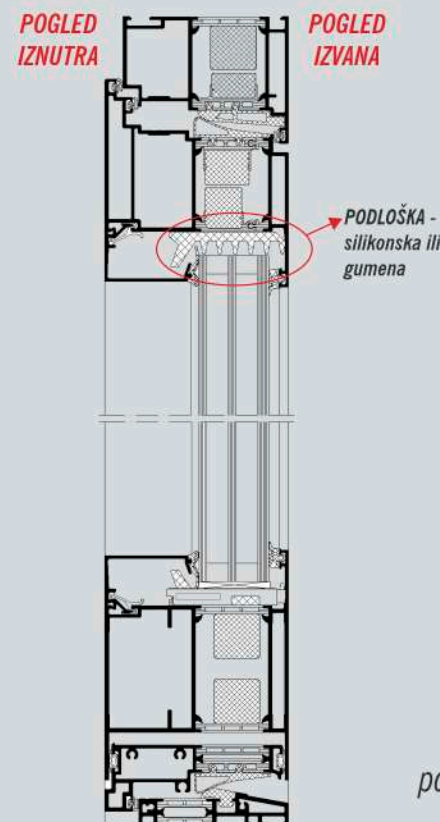

Da bi se izbjegla **deformacija panela** (PVC, ABS, HPL, ALU) - vanjska ploča dekorativnog panela **NIKAKO NE SMIJE BITI** fiksirana podloškom (kajlom), niti dodirivati gornju ni donju stijenku profila. Naime, između profila i vanjske ploče mora biti minimalno 3mm slobodnog prostora da bi ploča uslijed različitih vremenskih utjecaja imala prostora pri rastezanju i skupljanju (u skladu sa svojstvima svakog pojedinog materijala od kojeg je načinjen panel). Ukoliko se dekorativni panel ipak mora fiksirati podloškom (što nikako nije naša preporuka) **NE SMIJE** se fiksirati vanjska stijenka dekorativnog panela, već samo dio od unutarnje ploče do ojačanja dekorativnog panela (na slici).

Napomena:

Za gore prikazane proizvode molimo provjeriti dostupnost željenog proizvoda na našem prodajnom mjestu (Zagrebačka 49 K, Sisak ili Trstenička 2, Zagreb), pozivom na telefonski broj + 385 44 720 752; +385 1 3020 752 ili na e-mail: zoma@sk.t-com.hr.

Modele vrata ne proizvodimo u svim bojama navedenim u katalogu.

Dostupne boje su:

- bijela obostrano
- orah obostrano
- zlatni hrast obostrano
- antracit obostrano
- orah izvana - bijela unutra
- zlatni hrast izvana - bijela unutra
- antracit izvana - bijela unutra